



OmniHub 6/6D

User Manual



Copyright

© 2019 Sencore, Inc. All rights reserved.

3200 Sencore Drive, Sioux Falls, SD USA www.sencore.com.

This publication includes confidential, proprietary, and trade secret information. No part of this document may be copied, photocopied, reproduced, translated, or reduced to any machine-readable or electronic format without prior written permission from Sencore. Information in this document is subject to change without notice and Sencore Inc. assumes no responsibility or liability for any errors or inaccuracies. Sencore, Sencore Inc, and the Sencore logo are trademarks or registered trademarks in the United States and other countries. All other products or services mentioned in this document are identified by the trademarks, service marks, or product names as designated by the companies who market those products. Inquiries should be made directly to those companies. This document may also have links to third-party web pages that are beyond the control of Sencore. The presence of such links does not imply that Sencore endorses or recommends the content on those pages. Sencore acknowledges the use of third-party open source software and licenses in some Sencore products. This freely available source code can be obtained by contacting Sencore Inc.







About Sencore

Sencore is an engineering leader in the development of high-quality signal transmission solutions for the broadcast, cable, satellite, IPTV, telecommunications, and professional audio/video markets. The company's world-class portfolio includes video delivery products, system monitoring and analysis solutions, and test and measurement equipment, all designed to support system interoperability and backed by best-in-class customer support. Sencore meets the rapidly changing needs of modern media by ensuring the efficient delivery of high-quality video from the source to the home. For more information, visit www.sencore.com

Revision History

Date	Version	Description	Author
06/27/19	1.1	Initial Release	JTF
12/06/19	1.2	Add New Modules	EH
05/24/20	1.3	Update UI and add new modules	RS
07/26/20	1.4	Update descrambling configuration descriptions	SW

This guide contains some symbols to call your attention.

	DANGER	The DANGER symbol calls your attention to a situation that, if ignored, may cause physical harm to the user.
	CAUTION	The CAUTION symbol calls your attention to a situation that, if ignored, may cause damage to Our product.
	NOTE	The NOTE symbol calls your attention to important information.
	TIP	The TIP symbol calls your attention to additional information that, if followed, can make procedures more efficient.
	Red Arrow	The Red Arrow symbols point to import details mention the context above or below an image.
	Blue Arrow	The Blue Arrow symbol indicates the motion path of an item in an operation step.
	Thick Arrow	The thick Arrow symbol calls your attention to a serial of operation steps mentioned in the context.

This guide also contains the following text conventions.

Safety Instructions

- Read these instructions
- Keep these instructions
- Heed all warnings
- Follow all instructions
- Do not use this apparatus near water
- Clean only with dry cloth
- Do not block any ventilation openings. Install the unit in accordance with the manufacturer's instructions
- Do not install near any heat sources such as radiators, heat registers, stoves, or other apparatus (including amplifiers) that produce heat
- Do not defeat the safety purpose of the polarized or grounding-type plug. A polarized plug has two blades with one wider than the other. A grounding type plug has two blades and a third grounding prong. The wide blade or the third prong is provided for your safety. If the provided plug does not fit into your outlet, consult an electrician for replacement of the obsolete outlet.
- Protect the power cord from being walked on or pinched particularly at plugs, convenience receptacles, and the point where they exit from the apparatus.
- Only use attachments/accessories specified by the manufacturer.
- Unplug this apparatus during lightning storms or when unused for long periods of time.
- Refer all servicing to qualified service personnel. Servicing is required when the apparatus has been damaged in any way, such as power-supply cord or plug is damaged, liquid has been spilled or objects have fallen into the apparatus, the apparatus has been exposed to rain or moisture, does not operate normally, or has been dropped.
- Do not expose this apparatus to dripping or splashing and ensure that no objects filled with liquids, such as vases, are placed on the apparatus.
- To completely disconnect this apparatus from the AC Mains, disconnect the power supply cord plug from the AC receptacle.
- The mains plug of the power supply cord shall remain readily operable.
- **Damage Requiring Service:** Unplug this product from the wall outlet and refer servicing to qualified service personnel under the following conditions:
 - When the power-supply cord or plug is damaged.
 - If liquid has been spilled, or objects have fallen into the product.
 - If the product has been exposed to rain or water.
 - If the product does not operate normally by following the operating instructions. Adjust only those controls that are covered by the operating instructions as an improper adjustment of the controls may result in damage and will often require extensive work by a qualified technician to restore the product to its normal operation.
 - If the product has been dropped or damaged in any way.
 - The product exhibits a distinct change in performance.
- **Replacement Parts:** When replacement parts are required, be sure the service technician uses replacement parts specified by Sencore, or parts having the same operating characteristics as the original parts. Unauthorized part substitutions made may result in fire, electric shock or other hazards.

SAFETY PRECAUTIONS

There is always a danger present when using electronic equipment.

Unexpected high voltages can be present at unusual locations in defective equipment and signal distribution systems. Become familiar with the equipment that you are working with and observe the following safety precautions.

- Every precaution has been taken in the design of your product to ensure that it is as safe as possible. However, safe operation depends on you the operator.
- Always be sure your equipment is in good working order. Ensure that all points of connection are secure to the chassis and that protective covers are in place and secured with fasteners.
- Never work alone when working in hazardous conditions. Always have another person close by in case of an accident.
- Always refer to the manual for safe operation. If you have a question about the application or operation email ProCare@Sencore.com
- **WARNING** – To reduce the risk of fire or electrical shock never allow your equipment to be exposed to water, rain or high moisture environments. If it is exposed to a liquid, remove power safely (at the breaker) and send your equipment to be serviced by a qualified technician.
- To reduce the risk of shock the power supply must be connected to a mains socket outlet with a protective earthing connection.
- For the mains plug the main disconnect and should remain readily accessible and operable at all times.
- When utilizing DC power supply, the power supply **MUST** be used in conjunction with an over-current protective device rated at 50 V, 5 A, type: Slow-blow, as part of battery-supply circuit.
- To reduce the risk of shock and damage to equipment, it is recommended to ground the unit to the installation's rack, the vehicle's chassis, the battery's negative terminal, and/or earth ground.

⚠ Warning: Changes or modifications to this unit not expressly approved by the party responsible for compliance could void the user's authority to operate the equipment.

Package Contents

The following is a list of the items should be contained:

1. OmniHub 6 chassis
2. OmniHub 6 software
3. AC power cables
4. Breakout or adapter cables depending on option modules

If any of these items were omitted from the packaging please email ProCare@Sencore.com to obtain a replacement.

Table of Contents

SECTION 1 OVERVIEW	9
1.1 PRODUCT OVERVIEW.....	10
1.2 FRONT PANEL OVERVIEW.....	10
1.3 REAR PANEL OVERVIEW	11
1.4 OPTION MODULE OVERVIEW.....	11
SECTION 2 INSTALLATION	16
2.1 RACK INSTALLATION	17
2.2 AC POWER CONNECTION.....	17
SECTION 3 WEB INTERFACE OPERATION	19
3.1 OMNIHUB 6/6D WEB INTERFACE OVERVIEW.....	20
3.1.1 Connecting to the Management Port	20
3.1.2 Logging into the OmniHub 6/6D Web Interface	20
3.2 STATUS OVERVIEW	20
3.2.1 Status	21
3.2.2 System Setting.....	21
3.2.3 IP Input.....	23
3.2.4 IP Output.....	27
3.2.5 Admin.....	30
3.3 RECEIVER MODULES.....	31
3.3.1 OHR6-DVBC-00.....	31
3.3.2 OHR6-DVBC-ISDBT-01	35
3.3.3 VBS2CI-00.....	36
3.3.4 BS2FTA-00/00A	37
3.3.5 OHR6-8VSB-00	37
3.3.6 BT2CI-00.....	43
3.3 ENCODER MODULES.....	45
3.4.1 OHE6-HDMI-00/R01.....	45
3.4.2 OHE6-HDMI-02.....	54
3.4.3 OHE6-HDMI-02C	58
3.4.4 OHE6-HDMI-05/05A.....	62
3.4.5 OHE6-SDI-00.....	67
3.4.6 OHE6-CVBS-00/R01/R01A.....	70
3.5 MODULATION MODULES	75
3.5.1 OHM6-QAMA-00/R00.....	75
3.5.2 OHM6-QAMA-R01/R01A.....	79
3.5.3 OHM6-QAMB-00/R00	79
3.5.4 OHM6-QAMB-R01/R01A.....	80
3.5.5 OHM6-8VSB-R01/R01A.....	81
3.5.6 OHM6-OFDM-R01/R01A.....	82
3.5.7 OHM6-ISDBT-R01/R01A.....	83
3.6 FUNCTION MODULES	85
3.6.1 OHP6-EAS.....	85
3.6.2 OHP6-CAM-00.....	88
3.6.3 OHP6-EIT-00.....	90
SECTION 4 APPENDICES	92
APPENDIX A - ACRONYMS AND GLOSSARY.....	93
APPENDIX B - AMONROE ONE.NETSE CONFIGURATION AND TESTING	94

APPENDIX C - SPECIFICATION97
APPENDIX D - WARRANTY111
APPENDIX E - SUPPORT AND CONTACT INFORMATION111
 1 *Returning for Service or Calibration*111
 2 *RMA Number*.....111
 3 *Shipping the Product*.....111

Section 1 Overview



SECTION 1 OVERVIEW	9
1.1 PRODUCT OVERVIEW.....	10
1.2 FRONT PANEL OVERVIEW.....	10
1.3 REAR PANEL OVERVIEW.....	11
1.4 OPTION MODULE OVERVIEW.....	11

1.1 Product Overview

OmniHub 6/6D is a compact, highly integrated and flexible solutions that focuses on both cost-effective commercial TV market and traditional DTV market. Thanks to the benefits of high-density, strong-performance and large-flexibility, OmniHub 6/6D can meet all the major video delivery requirements of receiving, descrambling, encoding, multiplexing, modulation, and IP processing of signal in one unit.

With optional commercial/broadcast encoder, multi-mode receiver and modulator module, it can be configured flexibly to meet any video delivery requirements. Due to its compact design and powerful function, it can be widely used at hotel, hospital, communities, clubs, campuses and or other places with DTV headend, where massive programs are required to be processed in a cost-effective way. OmniHub 6/6D provides a straight-forward web interface accessible via all major browsers and complete control of the unit. Every OmniHub 6/6D is shipped with the software suite pre-loaded on appropriate hardware. There are optional input and output configurations that will change the physical connectors available on the chassis.

1.2 Front Panel Overview

As a 1RU unit, on the front panel, OmniHub 6 has exhaust fans, ports for data and management, and LED for the status of the unit. See the image below for the reference of the OmniHub 6 front panel.



1. Vent holes for cooling intake
2. Four 1GbE RJ45 ports: two for management and two for MPEG over IP purposes
3. Status indicators of the chassis and modules

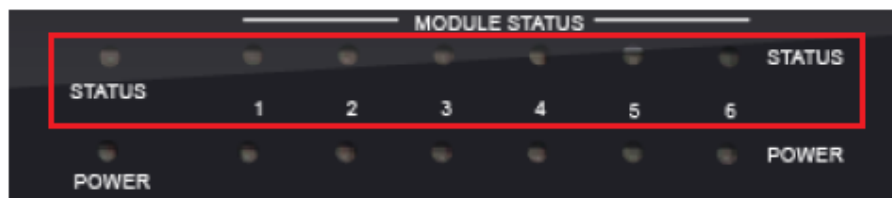

Power indicators of the chassis and modules

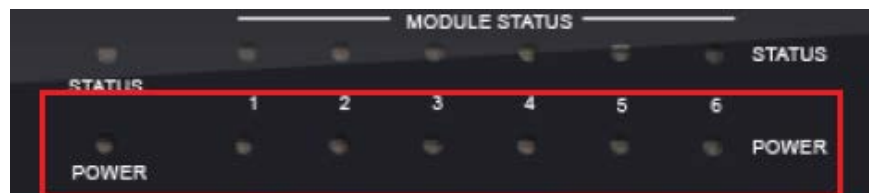

4. Reset Button

1.3 Rear Panel Overview

The OmniHub 6 has multiple options for the backplane configuration. Device can be ordered with Single Power Supply (order number – OmniHub 6) or Dual Power Supply (order number – OmniHub 6D).

Rear panel of the device with single power supply:



1. Slot no.1 for the option module
2. Slot no.2 for the option module
3. Slot no.3 for the option module
4. Slot no.4 for the option module
5. Slot no.5 for the option module
6. Slot no.6 for the option module
7. Ground
8. Single Power Supply

Rear panel of the device with dual power supply:



1. Slot no.1 for the option module
2. Slot no.2 for the option module
3. Slot no.3 for the option module
4. Slot no.4 for the option module
5. Slot no.5 for the option module
6. Slot no.6 for the option module
7. Ground
8. Dual Power Supply

1.4 Option Module Overview

This describes the OmniHub 6/6D platform and all available modules that can expand the functionality of the OmniHub 6/6 platform.

OmniHub 6 chassis	Description
OmniHub 6	1RU chassis, Single PSU, 4xGbE ports, 14 LEDs and six hot swappable slots

OmniHub 6D	1RU chassis, Dual PSU, 4xGbE ports, 14 LEDs and six hot swappable slots
OH-AC3-AAC-4CH	AC3 (2-channel stereo audio) and AAC license per 4 channels encoder module
OH-AC3-AAC-8CH	AC3 (2-channel stereo audio) and AAC license per 8 channels encoder module

Receiver Modules	Description
OHR6-DVBC-00	4 channel DVB-C Annex A/C/DTMB receiving module, 1 RF input connector with 4 tuners and 2 CI slots
OHR6-DVBC-ISDBT-01	4 channel DVB-C Annex B/ISDBT receiving module, 1 RF input connected with 4 tuners and 2 CI slots
OHR6-DVBS2CI-00	4 channel DVB-S2 receiving module, 2 input connectors each with 2 transponders receiving, with 2 CI slots and independent power supplies for each LNB.
OHR6-DVBS2FTA-00	4 channel DVB-S2 receiving module, 4 input connectors. Independent power supplies for LNB 1 and 3 only.
OHR6-DVBS2FTA-00A	8 channel DVB-S2 receiving module, another interface card added on OHR6-DVBS2FTA-00, each module occupies 2 slots.
OHR6-8VSB-00	4 channel 8VSB receiving module, 4 input connectors with 4 tuners.
OHR6-DVBT2CI-00	4 channel DVB-T/T2 receiving module, 1 input connected with 4 tuners and 2 CI slots.

Encoder Modules	Description
OHE6-HDMI-00	4 channel HDMI encoding module, supports H.264 HD/SD, MPEG-2 SD, MPEG1L2, and optional AC3/AAC.
OHE6-HDMI-R01	4 channel HDMI encoding module, supports H.264 HD/SD, MPEG-2 SD, MPEG1L2, and optional AC3/AAC.

	Support OSD subtitle, logo picture and QR code overlay
OHE6-HDMI-02	2 channel HDMI encoding module, supports H.264 HD/SD, MPEG-2 SD, MPEG1L2, optional AC3/AAC, and supports CC input.
OHE6-HDMI-02C	2 channel HDMI encoding module, supports H.264 HD/SD, MPEG-2 SD, MPEG1L2, optional AC3/AAC and supports CC and analog audio input.
OHE6-HDMI-05	4 channel HDMI encoding module, supports H.264/H.265 HD/SD, MPEG-2 SD, MPEG1L2, optional AC3/AAC, and support OSD subtitle, logo picture and QR code overlay.
OHE6-HDMI-05	8 channel HDMI encoding module, supports H.264/H.265 HD/SD, MPEG-2 SD, MPEG1L2, optional AC3/AAC, and support OSD subtitle, logo picture and QR code overlay, each module occupies 2 slots,
OHE6-CVBS-00	6 channel CVBS encoding module, supports H.264/MPEG-2 SD, MPEG1L2.
OHE6-CVBS-R01	8 channel CVBS encoding module, supports H.264, MPEG1L2.
OHE6-CVBS-R01A	16 channel CVBS encoding module, supports H.264, MPEG1L2, the modules occupy 2 slots.
OHE6-SDI-00	2 channel SDI encoder bitrate supports H.264/MPEG-2 HD/SD, MPEG1L2, AAC and AC3 are optional, and supports CC and analog audio input.

Modulator Module	Description
OHM6-QAMA-R00	16 channel QAM modulator module, Annex A/C, non-adjacent output, and 1 RF female port for output
OHM6-QAMB-R00	16 channel QAM modulator module, Annex B, non-adjacent output, and 1 RF

	female port for output
OHM6-QAMA-R01	4 channel QAM modulator module, Annex A/C, adjacent output, and 1 RF female port for output
OHM6-QAMA-R01A	8 channel QAM modulation module, Annex A/C, adjacent output, and 1 RF female port for output
OHM6-QAMB-R01	4 channel QAM modulation module, Annex B, adjacent output, and 1 RF female port for output
OHM6-QAMB-R01A	8 channel QAM modulation module, Annex B, adjacent output, and 1 RF female port for output
OHM6-OFDM-R01	4 channel OFDM modulation module, adjacent output, and 1 RF female port for output
OHM6-OFDM-R01A	8 channel OFDM modulation module, adjacent output, and 1 RF female port for output.
OHM6-ISDBT-R01	4 channel ISDBT modulation module, adjacent output, and 1 RF female port for output.
OHM6-ISDBT-R01A	8 channel ISDBT modulation module, adjacent output, and 1 RF female port for output
OHM6-8VSB-R01	4 channel 8VSB (ATSC) modulation module, adjacent output, and 1 RF female port for output
OHM6-8VSB-R01A	8 channel 8VSB (ATSC) modulation module, adjacent output, and 1 RF female port for output.

Function Modules	Description
OHP6-EAS-00	EAS processing module, supports EAS triggering by analogue EAS input and Digital EAS input.
OHP6-CAM-00	CAM processing module supports 2 independent CI Card slots, support

	Xcrypt CA scramble, compatible with mainstream CAM cards, and support mainstream CAS decryption
OHP6-EIT-00	EIT processing module, supports up to 16TS per module

Section 2 Installation



SECTION 2 INSTALLATION	错误！未定义书签。
2.1 RACK INSTALLATION	错误！未定义书签。
2.2 AC POWER CONNECTION	错误！未定义书签。

2.1 Rack Installation

The OmniHub 6/6D is designed to be mounted in a standard 19" rack. It takes 1RU of rack space. To install it into a rack, please use the following steps:

- Determine the desired position in the rack for the OmniHub 6/6D. Make sure that the air intake on the front of the unit and the exhausts on the back of the unit will not be blocked.
- Install the brackets at the desired position if there's no supporting plate in the rack.

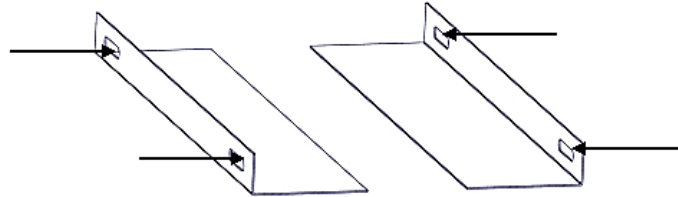

- Insert the rack mount clips into the place over the mounting holes in the rack.
- Slide the OmniHub 6/6D into the position in the rack.
- Secure the chassis to the rack by installing the four supplied screws through the front mounting holes and tightening.

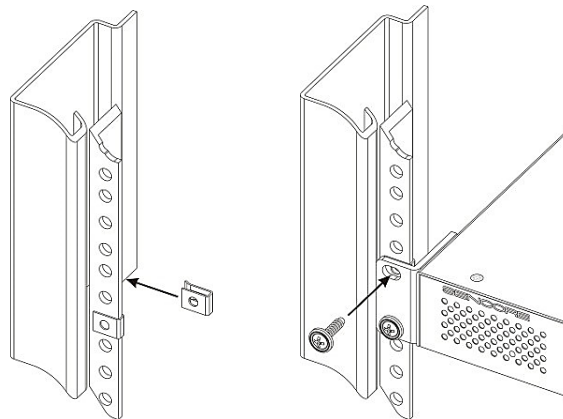

2.2 AC Power Connection

The Dual Redundant option allows the OmniHub 6/6D to be powered by two separate supplies either operating 110V or 220V systems. The power supply will automatically detect the system it is connected to. To hook up the power use the following steps:

- Locate the power cords that are contained. Please only use the supplied 3-prong power connector or one with equal specifications. NEVER tamper with or remove the grounding pin. This could cause damage to OmniHub 6/6D, personnel, or property.
- Plug the female end of the power cords into the front of the unit.
- Locate a protected outlet to plug the male ends of the power cables into.



When you take the equipment from a cold condition into a much warmer and humid condition, the equipment should be acclimated to the warm and humidity condition for at least 30 minutes. Powering up a non-acclimated unit may lead to shortcut or other damage to electronic components.



A professional UPS system is recommended for better performance of your content distribution system.

Section 3 Web Interface Operation



SECTION 3 WEB INTERFACE OPERATION	19
3.1 OMNIHUB 6/6D WEB INTERFACE OVERVIEW.....	20
3.1.1 Connecting to the Management Port	20
3.1.2 Logging into the OmniHub 6/6D Web Interface	20
3.2 STATUS OVERVIEW	20
3.2.1 Status	21
3.2.2 System Setting.....	21
3.2.3 IP Input.....	23
3.2.4 IP Output.....	27
3.2.5 Admin.....	30
3.3 RECEIVER MODULES.....	31
3.3.1 OHR6-DVBC-00.....	31
3.3.2 OHR6-DVBC-ISDBT-01	35
3.3.3 VBS2CI-00.....	36
3.3.4 BS2FTA-00/00A	37
3.3.5 OHR6-8VSB-00	37
3.3.6 BT2CI-00.....	43
3.4 ENCODER MODULES	45
3.4.1 OHE6-HDMI-00/R01.....	45
3.4.2 OHE6-HDMI-02.....	54
3.4.3 OHE6-HDMI-02C	58
3.4.4 OHE6-HDMI-05/05A.....	62
3.4.5 OHE6-SDI-00.....	67
3.4.6 OHE6-CVBS-00/R01/R01A.....	70
3.5 MODULATION MODULES	75
3.5.1 OHM6-QAMA-00/R00.....	75
3.5.2 OHM6-QAMA-R01/R01A.....	79
3.5.3 OHM6-QAMB-00/R00	79
3.5.4 OHM6-QAMB-R01/R01A.....	80
3.5.5 OHM6-8VSB-R01/R01A.....	81
3.5.6 OHM6-OFDM-R01/R01A.....	82
3.5.7 OHM6-ISDBT-R01/R01A.....	83
3.6 FUNCTION MODULES	85
3.6.1 OHP6-EAS.....	85
3.6.2 OHP6-CAM-00.....	88
3.6.3 OHP6-EIT-00.....	90

3.1 OmniHub 6/6D Web Interface Overview

3.1.1 Connecting to the Management Port

OmniHub 6/6D has an embedded gigabit switch. The four network ports are respectively used for managing and data reception/streaming over IP network. From left to right, port 1 and port 2 are used for management purposes and, port 3 and port 4 are used for IP reception/streaming.

If an external IP switch needs to be installed between OmniHub 6/6D and other headend devices, this switch should support IGMP V2 and IGMP snooping function.

3.1.2 Logging into the OmniHub 6/6D Web Interface

To open the OmniHub 6/6D web interface use one of the following supported browsers and navigate to the unit's IP address:

- Firefox
- Google Chrome

Factory network settings of the Management Port:

- IP address: 192.168.1.10
- Subnet Mask: 255.255.255.0
- Gateway: 192.168.1.254

The user will need to login to the web interface. The default **username/password are admin/admin**. Click the login button to login to the web interface.

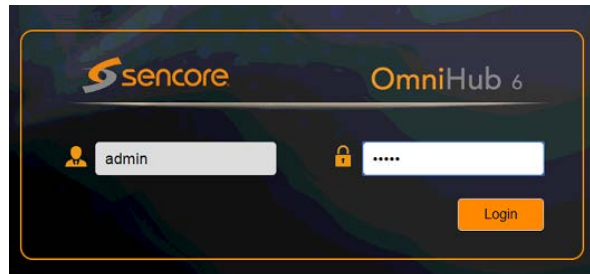

3.2 Status Overview

After a successful login, a welcome screen is displayed. The welcome screen allows you to navigate to:

1. Module List shows the module(s) installed inside the chassis
2. Settings buttons: status, system settings, IP inputs, IP outputs, admin
3. Device host operation status



3.2.1 Status

This Menu allows the user to access the following:

- Device Status
- Device Information

Device Status will show once you login to the OmniHub 6/6 web interface as shown in the picture above. It also shows the front and rear-view image of OmniHub 6/6 with friendly label that show the status of each module connected in the 6 slots.

Device Information page shows the firmware version, software version, and hardware version of the baseboard and every module physically installed. You can access Device Information Status page by clicking the button  and then the button



Status			
Module	Firmware Version	Software Version	Hardware Version
Baseboard	V0.2.586	V1.4.23	V1.0.1
2.OHR-DVBC-01	V46.3.256	V1.4.15	V0.1.0
3.OHM-QAMB-R01	V65.2.258	V1.4.7	V0.0.1
4.OHE-CVBS-00	V0.0.565	V1.4.4	V0.1.0
5.OHE-HDMI-01	V0.0.574	V1.4.4	V0.0.1
6.OHE-HDMI-R01	V0.0.574	V1.4.4	V1.1.1

3.2.2 System Setting

This menu allows you to configure:

- Network
- Time
- System
- Password
- SNMP

Network tab allows you to assign a static IP address to the OmniHub 6/6D mainboard only. IP addresses for boards/modules will be assigned automatically based on the address set for the chassis. To avoid IP address conflicts when you set the baseboard IP address, observe occupied IP sections displayed on this page in the top blue area.

System Setting Network **Time** System Password SNMP

Advanced Setting

Module Name	IP Address	Subnet Mask	Default Gateway	MAC Address	DNS Server IP
Baseboard	192.168.1.10	255.255.255.0	192.168.1.1	A0:69:86:01:DB:0C	0.0.0.0

Apply

Tips

1. When multiple equipments are connected to the same switch, please make sure to change the default baseboard IP address and internal IP address of baseboard / modules " + "at advanced setting to avoid IP conflict.
2. The IP conflict of baseboard / modules between different equipments will cause loading failure of modules for some equipments.
3. When the subnet of Internal Baseboard IP address is changed, the IP address of modules will follow the subnet change automatically.

Click the button  on the right side for the changes to take effect.

Time tab allows you to check the current system time, change the time zone, choose system time Mode (Manual or Automatic), enable/disable Auto Sync and modify NTP Server Address in Automatic mode and change the current system Time in Manual mode.

Network **Time** System Password SNMP

System Time Jun. 19th, 2019 13:07:41

Time Zone UTC +00: 00

Mode Manual

Time 2019/06/19 13:07:30

Apply

Network **Time** System Password SNMP

System Time Jun. 19th, 2019 13:11:07

Time Zone UTC +00: 00

Mode Automatic

NTP Server Address 192.168.1.113

Auto Sync Disable

Apply

Click the button  on the right side for the changes to take effect.

System tab allows you to do upgrade, import or export configuration, import or export licenses (*only baseboard*), reboot the whole unit, restore to factory default (*only baseboard*) and export logs and clear log (*only baseboard*).

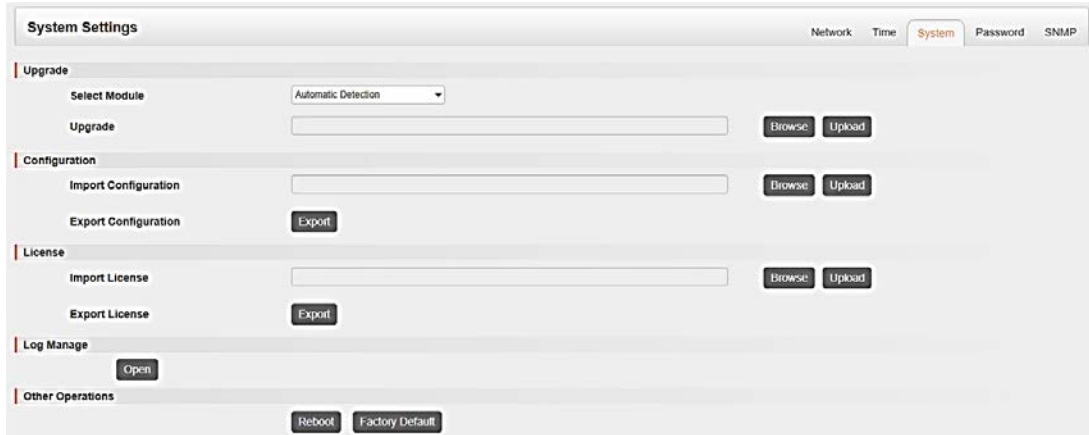

Click the button  on the right side for the changes to take effect.

Password tab allows you to change the login password.



Click the button  on the right side for the changes to take effect.

SNMP tab is for you to disable or enable the SNMP function.

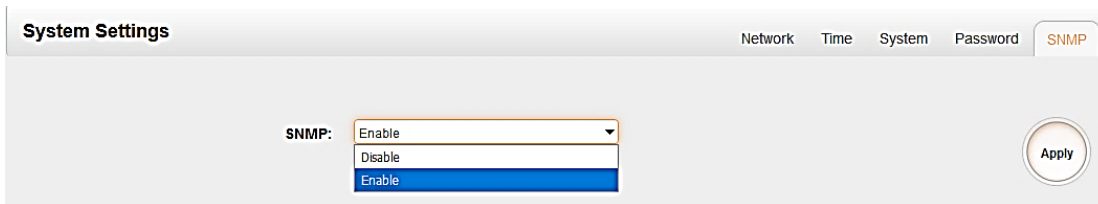

Click the button  on the right side for the changes to take effect.

3.2.3 IP Input

This menu allows you to configure and access the IP input:

- Status
- Basic Settings
- Service Configuration

Status tab displays a table of Channels with IP Address, IP Port, Effective Bitrate, Total Bitrate, TS Analysis and Service List for each IP input stream. OmniHub-16 IP input has a total of 120 channels which means it can accommodate 120 IP address multicast.

Once a channel is enabled, the IP address and IP port configured for the channel will appear in the table. If the source multicast is good, there will be a value under the total bitrate and effective bitrate showing the actual bitrate of the transport stream.

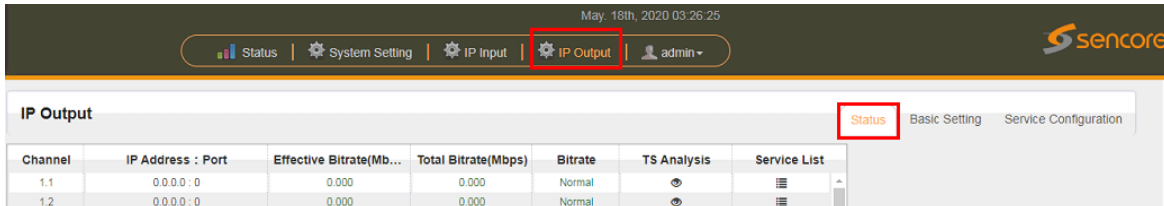

Clicking under TS Analysis button will display the information on the structure of the transport stream.

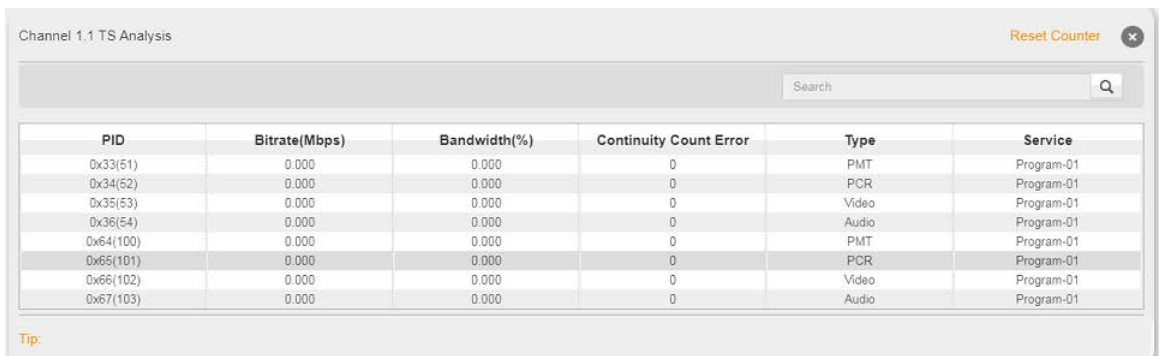

Clicking under Service List will display information on the services included in the transport stream. A list of services in the TS will be shown as the picture below.

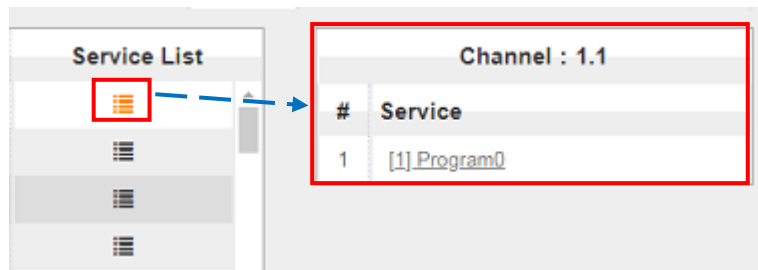

Clicking on the service in the list will display its detailed information: PCR, PMT, Video and Audio PID and Bitrate. See the picture below

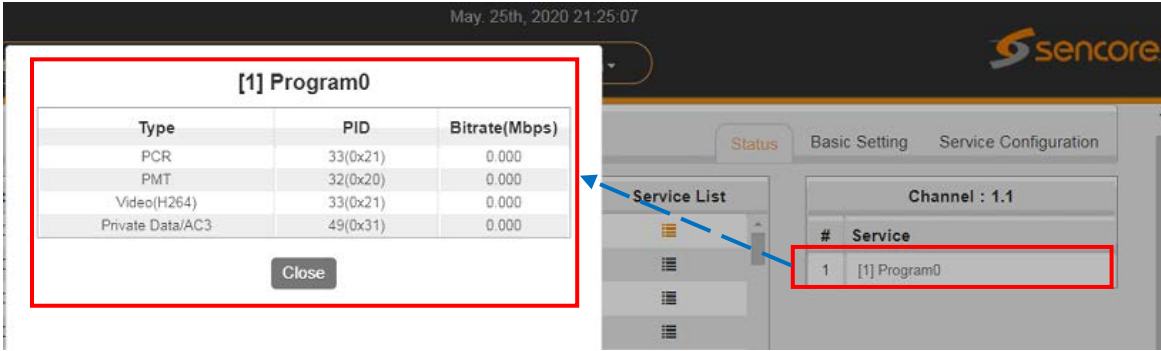

Basic Settings tab displays the configuration page of the IP input. You can enable the TS and set the input IP Address, IP port and Protocol of the source multicast.

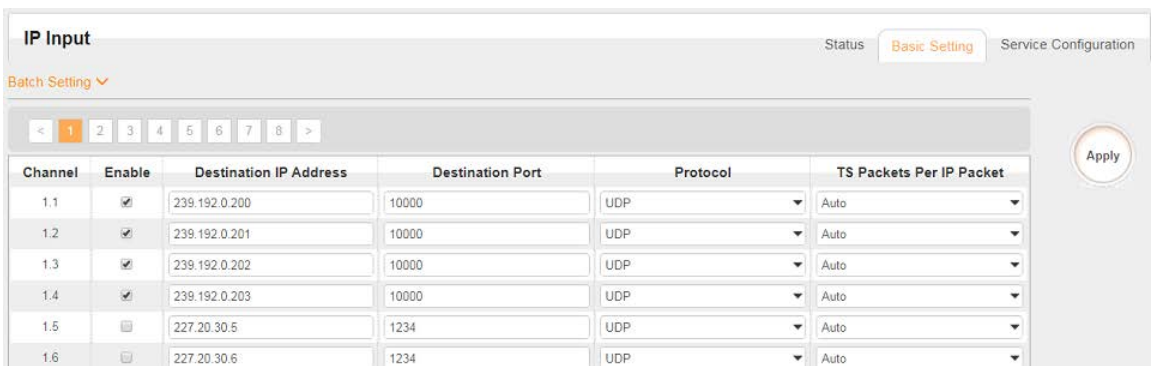

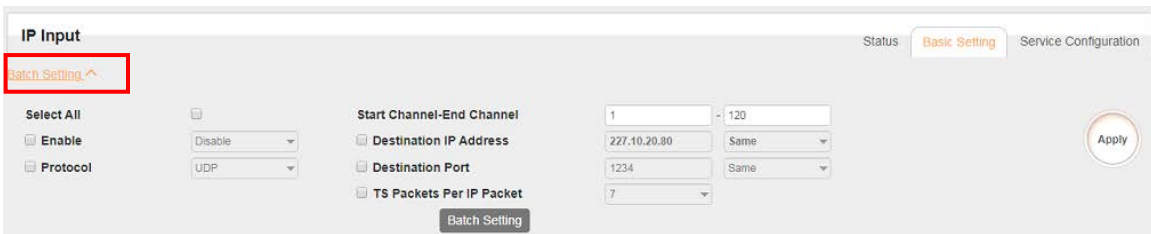

To enter many IP addresses for the inputs, click the Batch Setting **Batch Setting** button and fill in the following fields. You can only set the source when the IP addresses are in a consecutive order.



Click the Apply **Apply** button on the right side to make the change takes effect.

Service Configuration tab displays the configuration page where you can manage the received services and output them to their designated interface. Configuration steps for IP input and all receiving and encoding modules in OmniHub 6/6D are mostly the same.

First, you need to **Channel Scan** the port on each TS with LOCKED signal status. Each port might be scanned automatically or need to be scanned when its source signal is replaced.

After scanning each channel, you can output each transport stream or service by clicking the icon  and  below “Destination Settings”. You can route the whole

stream or a service/s from the input channel toward the available output channel (IP or RF). Two types of routing are possible.

1. **Bypass mode.** In this mode, routes can only be done when outputting a whole input transport stream towards an output TS channel - this cannot be done when outputting a single service only. Bypass mode activation will not allow other services from other input TS to be mixed in the current TS output. Any attempts of routing other stream/services towards this channel will result in *“this channel won’t be available at this time”*.
2. **Multiplex mode** is used to create a new SPTS or MPTS. This mode allows the administrator to perform the following operation:
 - a. Routes a single service towards an output channel to create SPTS
 - b. Routes services towards a single output channel to create MPTS
 - c. Route service/s AND stream/s from multiple channels towards a single output channel to create MPTS.

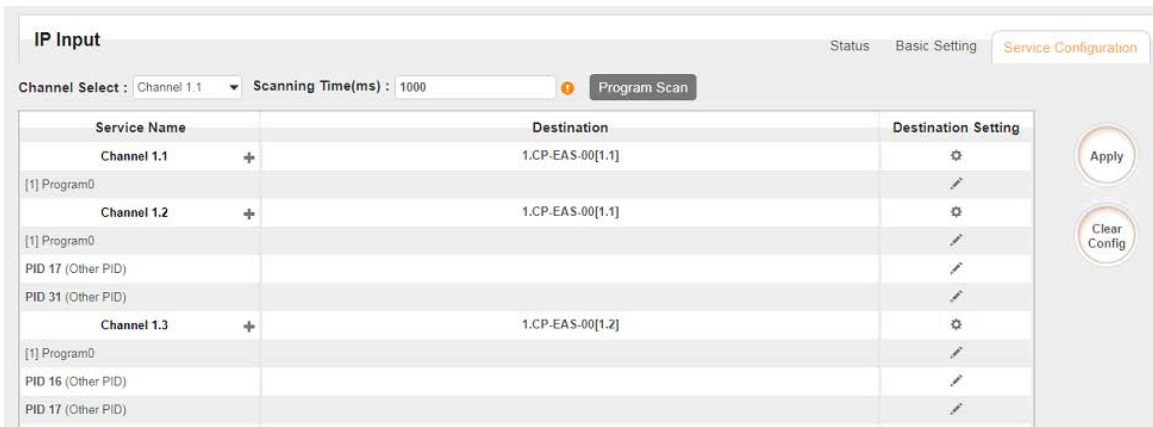

Service Configuration page interface

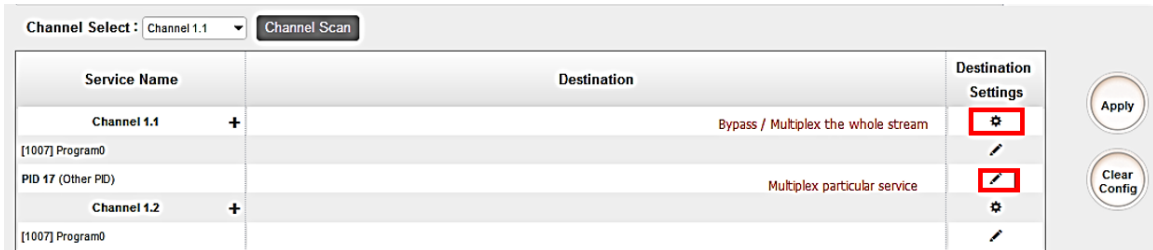

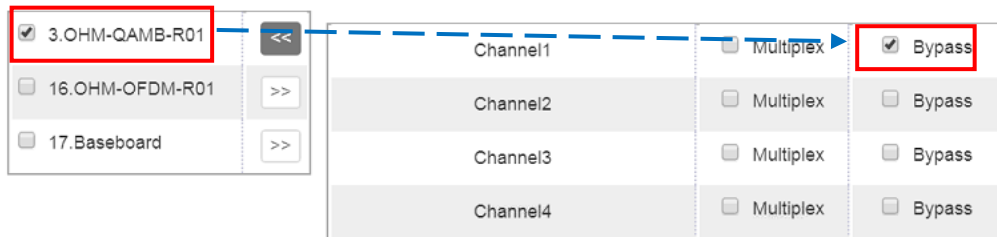

To use **Bypass** or **multiplex mode on stream level**, click the icon ⚙️. When a new window appears, select the output stream/channel where the stream will be bypassed or multiplexed.

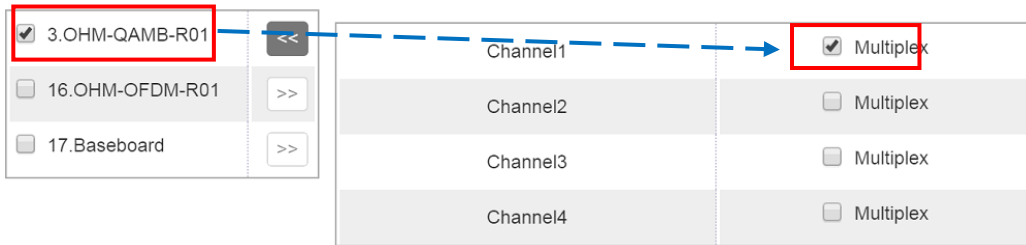

To use **Multiplexing mode on service level** click on pencil icon  on the right side in the line with the proper service. Then select the output stream (channel) where the service will be multiplexed.



Do not forget to click the Apply button  on the right side to make the change take effect.

 To clear the whole routing table click  button.

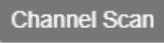
 There is a channel scan button  on the top. Normally the input service list of each channel will be loaded in this page automatically, but when you change the input source, you should refresh the changed channel manually by selecting the channel and clicking **Channel Scan** button.

3.2.4 IP Output

This menu allows you to configure and access the IP output:

- Status
- Basic Settings
- Service Configuration

Status tab displays the table of Channels, IP Address, IP port, Effective Bitrate, Total Bitrate, Bitrate Status (Normal/Overload), TS Analysis and Service List for each IP output stream. OmniHub 6/6D IP output has a total of 120 channels which means it can output 120 multicast IP addresses. Once a channel is enabled, the IP address and IP port configured on the channel will appear in the table. If there are services output in the channel, the status will display the effective and total bitrate. Total bitrate is the set maximum bitrate set and the effective bitrate is the actual bitrate of the service/s. If the actual bitrate is higher than the total bitrate, Bitrate status will display “overload” which indicates some errors in the channel.

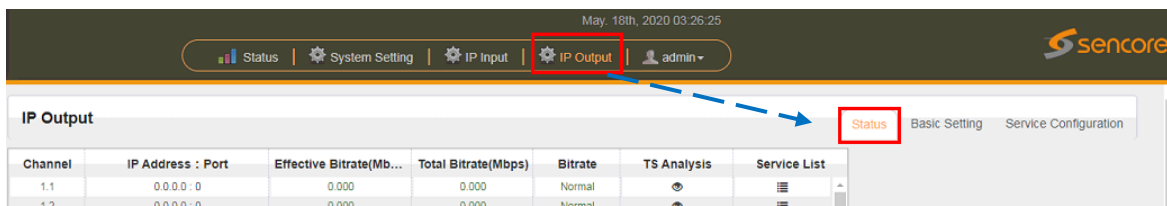

Clicking the icon under the TS Analysis button will display the information on the structure of the transport stream.

The top screenshot shows the 'IP Output' table with columns: Channel, IP Address : Port, Effective Bitrate(...), Total Bitrate(M...), Bitrate, TS Analysis, and Service List. A red box highlights the eye icon in the TS Analysis column for Channel 1.1. A blue dashed arrow points from this icon to the 'Channel 1.1 TS Analysis' window below.

The 'Channel 1.1 TS Analysis' window contains a table with the following data:

PID	Bitrate(Mbps)	Bandwidth(%)	Continuity Count Error	Type	Service
0x0(0)	0.015	0.025	127	PAT	
0x30(48)	0.015	0.025	119	PMT	KELO
0x31(49)	11.771	19.618	127	PCR \ Video	KELO
0x33(51)	0.015	0.025	57	PMT	KELO
0x34(52)	0.395	0.658	127	Audio	KELO
0x35(53)	0.198	0.330	76	Audio	KELO
0x36(54)	11.771	19.618	127	PCR \ Video	KELO
0x37(55)	0.395	0.658	127	Audio	KELO

Clicking  under Service List will display information on the services included in the transport stream. This will display the list of services in a TS as shown in the picture below.

The screenshot shows the 'Service List' on the left with a red box around the first service icon. A blue dashed arrow points from this icon to the 'Channel: 1.1' service details window on the right.

The 'Channel: 1.1' window displays a list of services:

#	Service
1	[3] KELO
2	[4] UTV
3	[5] ION
4	[6] Escape
5	[1] Program0
6	[2] KELO

Clicking on the service name in the list will display the detailed information of the service: PCR, PMT, Video and Audio PID and Bitrate as shown in the picture below.

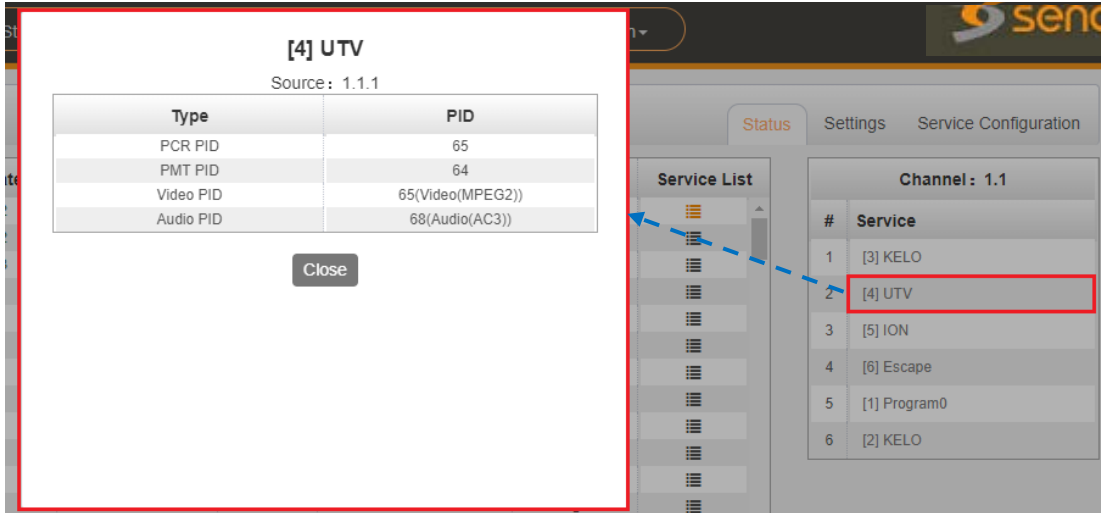

Basic Settings tab displays the configuration page of the IP output. You can enable the TS and set the output IP Address, IP port and Protocol of the Destination IP multicast.

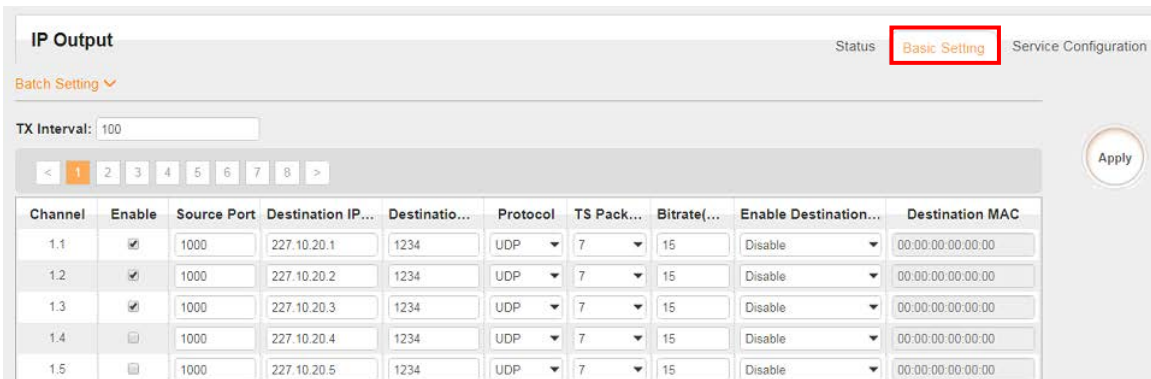

To enter many IP addresses, use the Batch Setting [Batch Setting](#) button and fill in the following fields. You can only set the destination IP address when the IP addresses are in a consecutive order

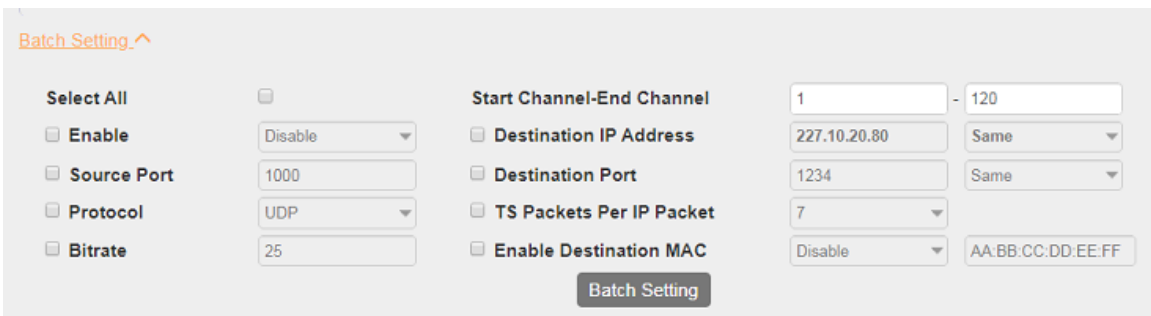

Click the Apply button  on the right side to make the change take effect.

Service Configuration tab display the page where you can check/edit output TS or services that are part of output IP streams. Streams can originates either from IP input,

receiver modules or encoder modules. In picture below, clicking the area marked as “click here”, you can make changes to the transport stream, i.e.:

- edit Original Network ID
- edit TS ID
- edit Service ID, Service Name and Service Provider
- edit PID ID for other PIDs

Click the Apply button  on the right side to make the change take effect.

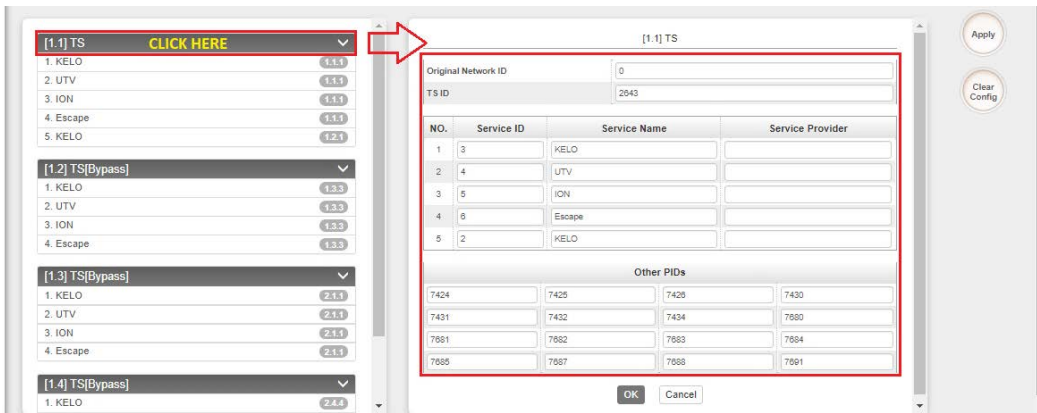

In picture below, clicking the area marked as “click here”, the user can make changes to particular service(s), i.e.:

- edit Service ID, service name and service provider
- edit PCR, PMT PIDs
- edit Elementary Stream PIDs (video, audio/s)
- edit Logical Channel Number

Click the Apply button  on the right side to make the change take effect.

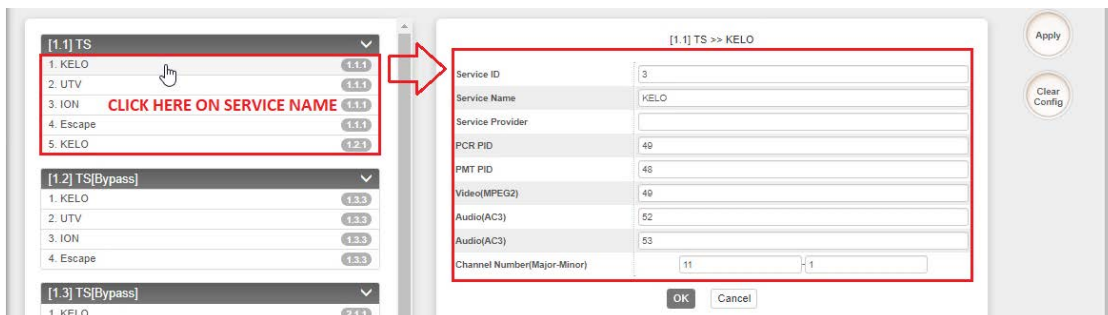

3.2.5 Admin

Click **Admin** and you can choose to go into Password setting page or Log Out.

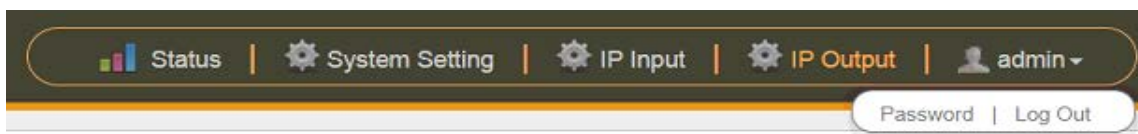

3.3 Receiver Modules

3.3.1 OHR6-DVBC-00

OHR6-DVBC-00 is a 4-channel DVBC receiving and descrambling module with 1 RF female connector and 2 CI slots. It can receive 4 DVBC signals simultaneously and support 2 CAM cards for descrambling.

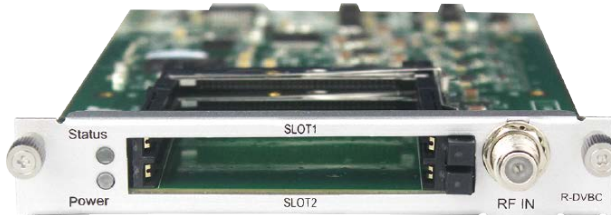

3.3.1.1 Module Status

By selecting the OHR6-DVBC-00 on the module list, you will be automatically redirected to the Status page of the module. This will display the channels from 1.1 to 1.4 that represent the 4 input -channels of the module. Once a channel is connected to the source and configured with correct parameters. The status of the channel will display 'locked' and you can see the values of the total bitrate and the actual bitrate.

OHR-DVBC-00							
Status CI Basic Setting Service Configuration System							
Channel	Locked Status	Total Bitrate(Mbps)	Effective Bitrate(Mbps)	PER	RF Level	TS Analysis	Service List
1.1	Unlocked	0.000	0.000	0.000000000	-		
1.2	Unlocked	0.000	0.000	0.000000000	-		
1.3	Unlocked	0.000	0.000	0.000000000	-		
1.4	Unlocked	0.000	0.000	0.000000000	-		

Total Bit rate in Mbps shows the bitrate of receiving signals of each channel with LOCKED status, while the Effective Bit Rate in Mbps shows its actual bitrate. RF Level of the input signal will show you the level of each locked channel.

Clicking under TS Analysis will display the information on the structure of the transport stream as shown in the picture below.

Channel 1.1 TS Analysis						
Reset Counter ✕						
<input type="text" value="Search"/> Q						
PID	Bitrate(Mbps)	Bandwidth(%)	Continuity Count Error	Type	Service	
0x33(51)	0.000	0.000	0	PMT	Program-01	
0x34(52)	0.000	0.000	0	PCR	Program-01	
0x35(53)	0.000	0.000	0	Video	Program-01	
0x36(54)	0.000	0.000	0	Audio	Program-01	
0x64(100)	0.000	0.000	0	PMT	Program-01	
0x65(101)	0.000	0.000	0	PCR	Program-01	
0x66(102)	0.000	0.000	0	Video	Program-01	
0x67(103)	0.000	0.000	0	Audio	Program-01	

Tip

Clicking  under Service List will display information on the services included in the transport stream. This will display the list of services in a TS as shown in the picture below.

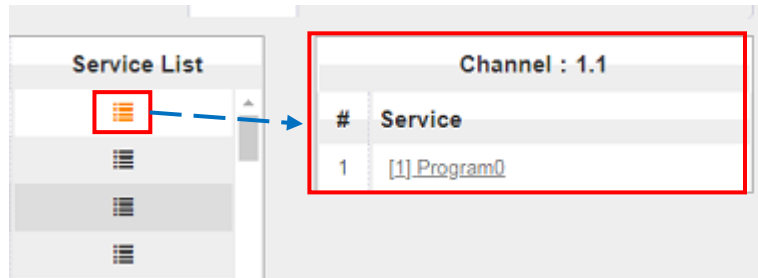

Clicking on the service name in the list will display the detailed information of the service: PCR, PMT, Video and Audio PID and Bitrate as shown in the picture below.

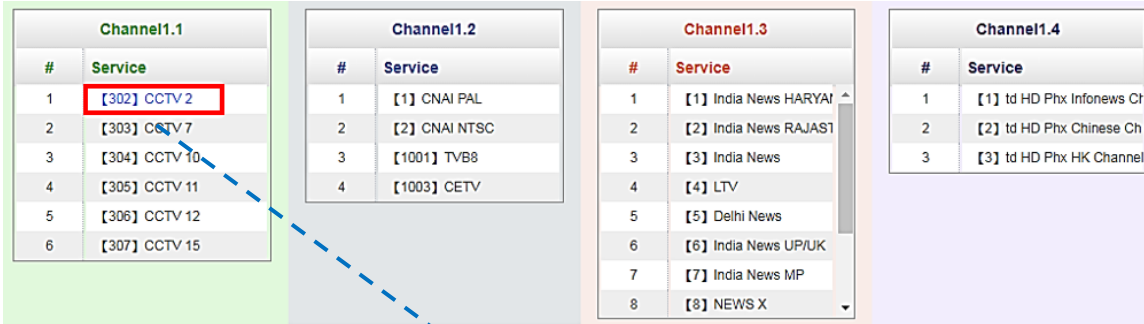



[302] CCTV 2

PID	Type	Bitrate(Mbps)
8190	PCR	0.045
258	PMT	0.018
513	StreamType:2-Video(MPEG2)	5.198
660	StreamType:4-Audio	0.262

3.3.1.2 Module CI

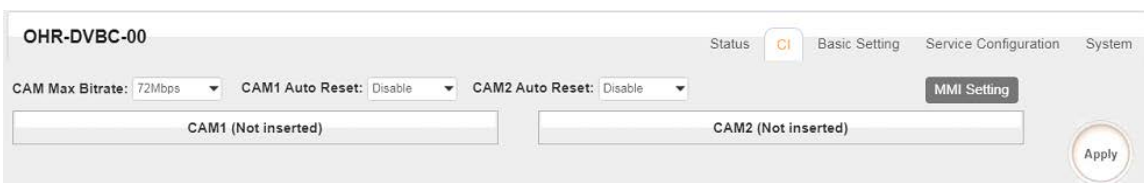
For the encrypted services received on OHR6-DVBC-00 module receiver, CI slot is needed to decrypt and re-broadcast the services. The OHR6-DVBC-00 has 2 CAM slots and can decrypt services depending on the capability of the CAM module and Smart Card. You can select the CAM Max Bit Rate from 48Mbps to 108Mbps in pull-down list depending on the total effective bitrate of services you want to decrypt at.



Click the Apply button  on the right side to make the change takes effect.

3.3.1.3 Module Settings

In this page you can input the parameters of the source signal. For DVBC input, it only needs to have the Frequency and Symbol Rate of the source. The range of the Frequency and Symbol Rate to be input on this page shows on the table below.

Name	Range
Frequency (KHz)	48000~862000
Symbol Rate (KBaud)	3000~7000

When the parameters are set, click on  and check in the Status page if the corresponding channel status is LOCKED.

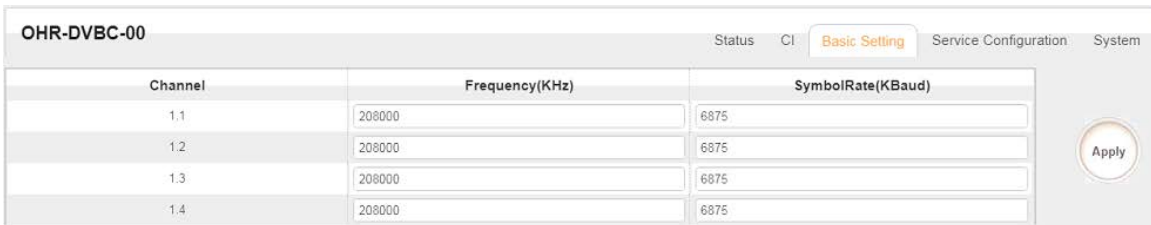



Channel	Frequency(KHz)	SymbolRate(KBaud)
1.1	208000	6875
1.2	208000	6875
1.3	208000	6875
1.4	208000	6875

3.3.1.4 Module Service Configurations

Service Configuration page is where you can manage the received services and output them to their designated interface. The configuration for all modules in OmniHub 6/6D is mostly same.

First, you need to scan the port on each LOCKED TS. Each port might be scanned automatically or needed to be scanned manually when its source is changed.

After scanning each channel, you can start to configure the services. You need to click **Apply** button after you configure service to CAM for descrambling, otherwise the descrambling configuration will not be saved. Then you can choose the services to be routed, you can output each service by clicking the icon  and  below “Destination Settings”. You can route a whole stream or a service/s from the input channel toward the available output channels (IP or RF). Two types of routing are possible.

1. **Bypass mode.** In this mode, you can route as whole input transport stream towards an IP or RF output which will be occupied only by this stream. Any attempt of routing other stream/service towards this channel will be an error. This can only be done when you click the icon  on the TS.
2. **Multiplex mode** is the counter part of the bypass mode. This mode allows the administrator to perform the following operations:
 - a. Route a single service towards an output channel to create SPTS.
 - b. Route services towards a single output channel to create MPTS.
 - c. Route service/s AND stream/s from multiple channels towards a single output channel to create MPTS.

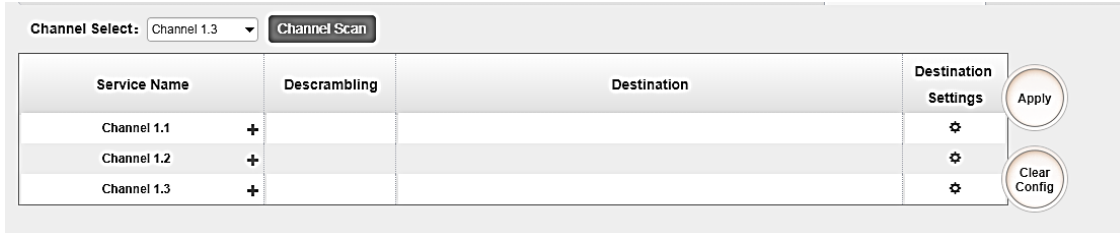

To use **Bypass or Multiplexing mode on stream level:**

1. Click on the (cog) icon ⚙️. There were always have BaseBoard selection for the IP output and other Output options depending on the modules inserted.
2. Select the correct Output and Channel you want to output the stream to.
3. Check Multiplex or Bypass on the Channel you want to output
4. Click the Apply button  on the right side to make the change takes effect.

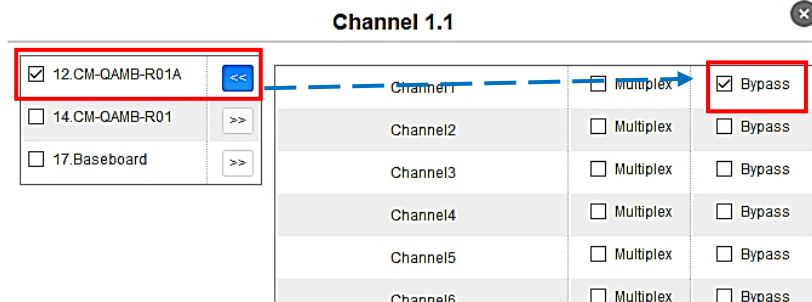
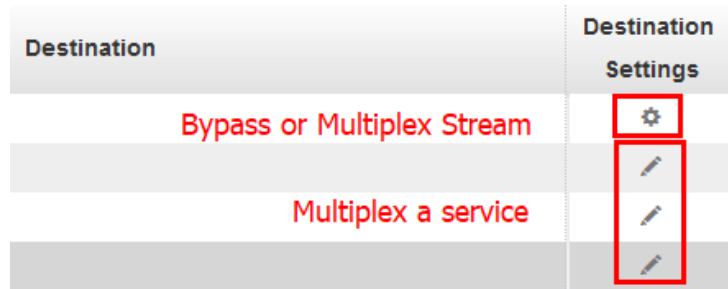

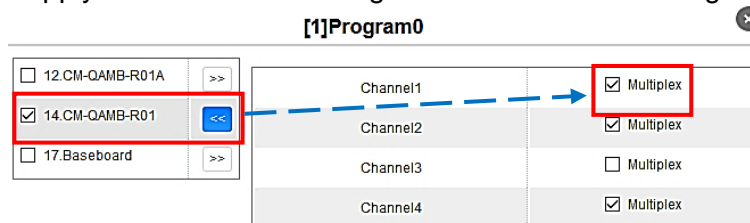

To use **Multiplexing mode on service level:**

1. Click on ✎ (pencil) icon. There will be always a BaseBoard selection for the IP output and other Output options depending on the modules inserted.
2. Select the correct Output and Channel you want to output the service to.
3. Check on Multiplex on the channel you want to output. You can output multiple service in one channel or output one service to multiple channels
4. Click the Apply button  on the right side to make the change takes effect.



 To clear the whole routing table click  button.

 There is a channel scan button  . Normally the input service list of each channel will show on this page, but when you change the input source, you should refresh the changed channels manually by selecting the channel and clicking **Channel Scan** button.

3.3.1.5 Module System Operation

In **System Operation** tab, you can choose the modulation type as DVBC Mode or DTMB Mode. Here you can also perform the following tasks:

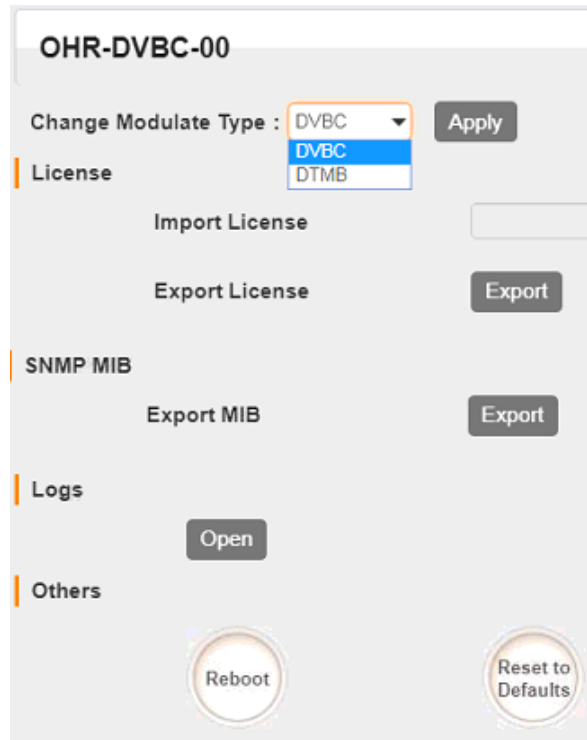

- Import / Export License
- Log Manage
- Reboot
- Factory Default the unit

3.3.2 OHR6-DVBC-ISDBT-01

OHR6-DVBC-ISDBT-01 is a 4-channel DVBC Annex B/ISDBT receiving and descrambling module with 1 RF female connector and 2 CI slots. The module can receive signals via 4 RF channels simultaneously and support 2 CAM cards for descrambling. Configuration of the module is very much similar to that of OHR6-DVBC-00. For configuration of this module, please refer to page 30 to 35.

OHR-DVBC-01						
Channel	Locked Status	Total Bitrate(Mbps)	Effective Bitrate(Mbps)	RF Level	TS Analysis	Service List
1.1	Unlocked	0.000	0.000	-	👁	☰
1.2	Unlocked	0.000	0.000	-	👁	
1.3	Unlocked	0.000	0.000	-	👁	
1.4	Unlocked	0.000	0.000	-	👁	

OHR-DVBC-01 Status CI Basic Setting Service Configuration System

Change Modulate Type: ANNEXB ANNEXB ISDBT Apply

License: Browse Upload

Export License: Export

3.3.3 VBS2CI-00

OHR6-DVBS2CI-00 is a 4-channel DVB-S/S2 receiving and descrambling module with 2 RF connectors and 2 CI slots, each RF connector can connect with 2 transponders. The module has independent power supplies for each LNB.

For Status and CI pages, please refer to OHR6-DVBC-00 module section on page 30 to 32.

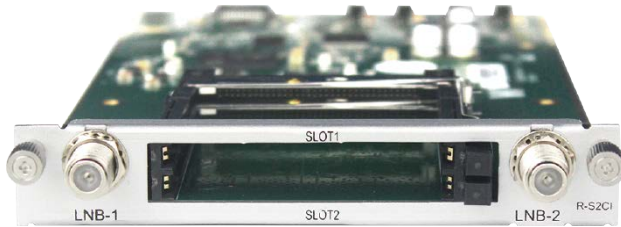

3.3.2.1 Module Settings

On the Parameter Settings page of OHR6-DVBS2CI-00 you can input information of the source signal. The table below show the parameter range of each field. For the LNB power, Channel 1.1 and 1.2 share power with each other from LNB-1, Channel 2.1 and 2.2 share power with each other from LNB-2.

Channel	Enable	Satellite Frequency(MHz)	SymbolRate(KBaud)	LNB Frequency(MHz)	LNB Power	LNB 22KHz
1.1	<input checked="" type="checkbox"/>	3840	27500	5150	off	off
1.2	<input type="checkbox"/>	3840	6875	5150		
2.1	<input type="checkbox"/>	3840	6875	5150	off	off
2.2	<input type="checkbox"/>	3840	6875	5150		

Name	Range
Satellite Frequency (KHz)	950000~2150000
Symbol Rate (KBaud)	1000~45000
LNB Frequency (KHz)	950000~21500000
LNB Power	Off/13V/18V
LNB 22KHz	Off/22KHz

3.3.4 BS2FTA-00/00A

OHR6-DVBS2FTA-00 is a 4channel DVB-S/S2 receiving module with 4RF connectors. The module supports internal signal pass through from one tuner to the others, while OHR6-DVBS2FTA-00A is the combination of 2 OHR6-DVBS2FTA-00 modules, it occupies 2 slots on the OmniHub 6/6D chassis and has an 8-channel DVBS-S2 receiving module with 8 RF connectors.



OHR6-DVBS2FTA-00



OHR6-DVBS2FTA-00A

OHR6-DVBS2FTA has a similar Status interface to OHR6-DVBS2CI. Differences between the 2 modules: 1) the number of received satellite signals (4/8 Satellite). 2) DVBS2CI can decrypt services using CAM module and Smart Card, while the DVBS2FTA use BISS decryption.

Channel	Locked Status	Total Bitrate(Mbps)	Effective Bitrate(Mbps)	RF Level	TS Analy...	Service List
1.1	Unlocked	0.000	0.000	-	👁️	📺
2.1	Unlocked	0.000	0.000	-	👁️	📺
3.1	Unlocked	0.000	0.000	-	👁️	📺
4.1	Unlocked	0.000	0.000	-	👁️	📺

The parameters for each port in Module Settings are also same with those of the OHR6-DVBS2CI and Service Configuration is same with that of OHR6-DVBC-00. Please refer to page 32 to 34 for the configuration manual.

3.3.5 OHR6-8VSB-00

OHR6-8VSB-00 is a 4-channel 8VSB receiving module with 4 RF connectors. Picture below shows the front plate of the 8VSB module.



Module specification:

- 4 RF female connectors
- Frequency range: 50 – 860MHz
- Bandwidth: 6MHz
- Modulation: 8VSB
- Signal Level: -80dBm ~ -20dBm

3.3.5.1 Module Status

Status page will display when you select the OHR6-8VSB-00 in the channel list. This shows the Channel Number, Locked Status, Total Bit Rate, Effective Bit Rate, TS Analysis and Service List for each 8VSB input stream. Once the channel is connected to the source and is set with the correct parameters. The status of the channel will display 'locked' and you can see the total bitrate and actual bitrate. Total Bit rate in Mbps shows the bitrate of receiving signals of each channel with LOCKED status, while the Effective Bit Rate in Mbps shows the actual bitrate of each receiving Channel. RF Level of the input signal will show you the level of each locked channel.

Channel	Locked Status	Total Bitrate(Mbps)	Effective Bitrate(Mbps)	RF Level	TS Analysis	Service List
1.1	Unlocked	0.000	0.000	-		
2.1	Unlocked	0.000	0.000	-		
3.1	Unlocked	0.000	0.000	-		
4.1	Unlocked	0.000	0.000	-		

Clicking the icon under TS Analysis will display the information on the structure of the transport stream as shown in the picture below.

Channel 1.1 TS Analysis Reset Counter

Search

PID	Bitrate(Mbps)	Bandwidth(%)	Continuity Count Error	Type	Service
0x33(51)	0.000	0.000	0	PMT	Program-01
0x34(52)	0.000	0.000	0	PCR	Program-01
0x35(53)	0.000	0.000	0	Video	Program-01
0x36(54)	0.000	0.000	0	Audio	Program-01
0x64(100)	0.000	0.000	0	PMT	Program-01
0x65(101)	0.000	0.000	0	PCR	Program-01
0x66(102)	0.000	0.000	0	Video	Program-01
0x67(103)	0.000	0.000	0	Audio	Program-01

Tip:

Clicking the icon under Service List will display information on the services included in the transport stream as shown in the picture below.

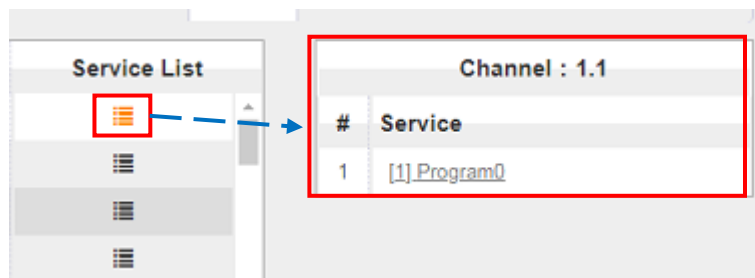

Clicking on the service name in the list will display the detailed information of the service: PCR, PMT, Video and Audio PID and Bitrate as shown in the picture below.

Channel1.1	
#	Service
1	[302] CCTV 2
2	[303] CCTV 7
3	[304] CCTV 10
4	[305] CCTV 11
5	[306] CCTV 12
6	[307] CCTV 15

Channel1.2	
#	Service
1	[1] CNAI PAL
2	[2] CNAI NTSC
3	[1001] TVB8
4	[1003] CETV

Channel1.3	
#	Service
1	[1] India News HARYAI
2	[2] India News RAJAST
3	[3] India News
4	[4] LTV
5	[5] Delhi News
6	[6] India News UP/JK
7	[7] India News MP
8	[8] NEWS X

Channel1.4	
#	Service
1	[1] td HD Phx Infonews Ct
2	[2] td HD Phx Chinese Ch
3	[3] td HD Phx HK Channel

[302] CCTV 2

PID	Type	Bitrate(Mbps)
8190	PCR	0.045
258	PMT	0.018
513	StreamType:2-Video(MPEG2)	5.198
660	StreamType:4-Audio	0.262

3.3.5.2 Module Settings

To make configuration changes in the context of the channel plan and the receiving frequency of a specific RF input, select the appropriate receiving module and then click on the **Settings** tab. The channel plan and frequency of a specific receiver can be selected using drop-down lists.

Table below presents supported channel plans.

Channel Plan	Frequency of RF Channels
Off-Air	CH2 57MHz, CH3 63MHz, CH4 69MHz~CH67 791MHz, CH68797MHz, CH69 803MHz
STD	CH2 57MHz, CH363MHz, CH4 69MHz~ CH133 849MHz, CH134855MHz, CH135 861MHz
IRC	CH2 57MHz, CH3 63MHz, CH4 69MHz ~ CH133 849MHz, CH134, 855MHz, CH135 861MHz
HRC	CH2 55.75MHz, CH3 61.75MHz, CH4 67.75MHz~ CH133847.75MHz, CH134 853.75MHz, CH135 859.75MHz

Channel Standard: Off-Air

Channel	CH
1.1	CH11-201MHz
2.1	CH11-201MHz
3.1	CH11-201MHz
4.1	CH11-201MHz

1: CR2-8VSB-00

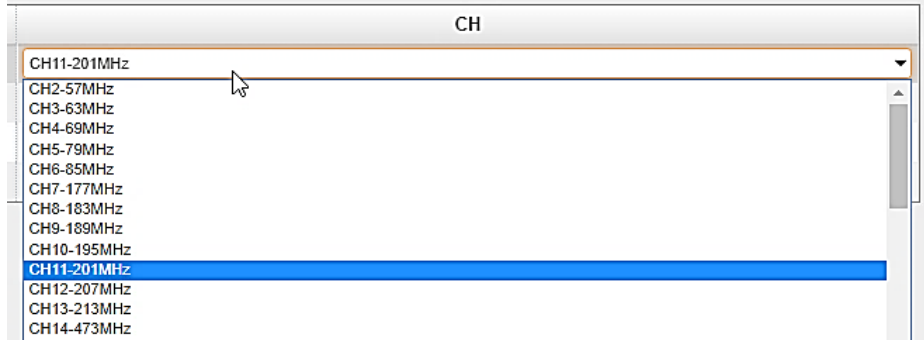

Channel Standard: Off-Air

- Off-Air
- STD
- IRC
- HRC



3.3.5.3 Modules Service Configuration

Service Configuration tab displays the configuration page where you can manage the received services and output them to their designated interface. Configuration steps for IP input and all receiving and encoding modules in OmniHub 6/6D are mostly the same. First, you need to scan the port of each TS with LOCKED signal status. Each port might be scanned automatically or need to be scanned manually one at a time when its source signal is replaced.

After scanning each channel, you can output each transport stream or service by clicking the icon  and  below “Destination Settings”. You can route the whole stream or a service/s from the input channel toward the available output channel (IP or RF). Two types of routing are possible

1. **Bypass mode.** In this mode, routes can only be done when outputting a whole input transport stream towards an output TS channel, this cannot be done when outputting a single service only. Bypass mode activation will not allow other services from other input TS to be mixed in the current TS output. Any attempts of routing other streams/services towards this channel will result in *“this channel won’t be available at this time”*.
2. **Multiplex mode** is used to create a new SPTS or MPTS. This mode allows the administrator to perform the following operations:
 - a. Route a single service towards an output channel to create SPTS.
 - b. Route services towards a single output channel to create MPTS.
 - c. Route service/s AND stream/s from multiple channels towards a single output channel to create MPTS.

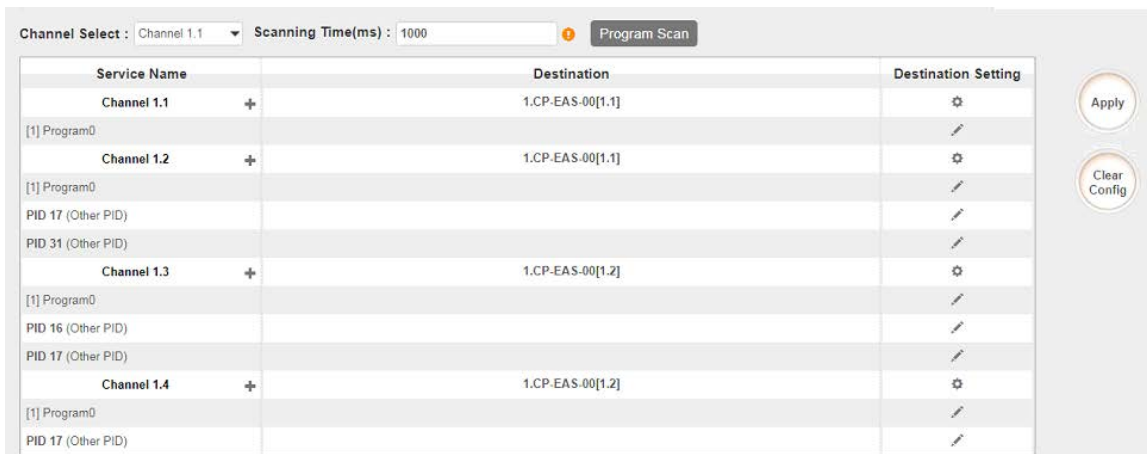

Service Configuration page interface

Destination	Destination Settings
Bypass or Multiplex Stream	
Multiplex a service	

To use **Bypass** or **multiplex mode on stream level**, click the icon . When a new window appears, select the output stream/channel where the stream will be bypassed or multiplexed.

To use **Multiplexing mode on service level** click on the pencil icon on the right side in the line with the proper service. Then select the output stream (channel) where the service will be multiplexed.

Do not forget to click the Apply button on the right side to make the change takes effect.

To clear the whole routing table, click button.

There is a channel scan button **Channel Select:** **Channel Scan** Normally the input service list of each channel will show on this page, but when you change the input source, you should refresh the changed channels manually by selecting the channel and clicking **Channel Scan** button.

3.3.5.4 Modules System

System tab allows you to perform the following tasks:

- Import / export license

- Log manages
- Reboot
- Factory Default

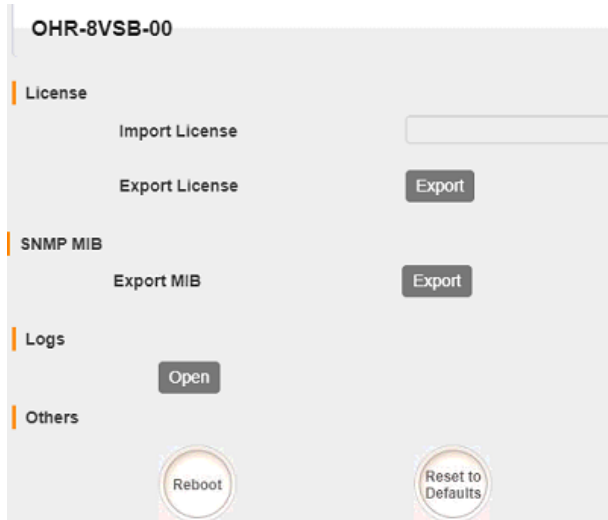

To open the log management menu, click on the **Open** button. The newly opened menu allows you to enable / disable logging.

After login is enabled, additional control buttons will be displayed:

- clean log, clean screen, export logs, filter dialog box



Filter

Level	
Level	Operation
Error	<input checked="" type="checkbox"/>
Warning	<input checked="" type="checkbox"/>
Information	<input checked="" type="checkbox"/>
Debug	<input type="checkbox"/>

Module List	
Module Name	Operation
SYS	<input checked="" type="checkbox"/>
PARAMS	<input checked="" type="checkbox"/>
UPGRADE	<input checked="" type="checkbox"/>
TSPROCESS	<input checked="" type="checkbox"/>
SIPROCESS	<input checked="" type="checkbox"/>
LICENSE	<input checked="" type="checkbox"/>

3.3.6 BT2CI-00

OHR6-DVBT2CI-00 is a 4-channel DVBT/T2 receiving and descrambling module with 1 RF female connector and 2 CI slots. It can receive signals via 4 RF channels simultaneously and support 2 CAM cards descrambling.

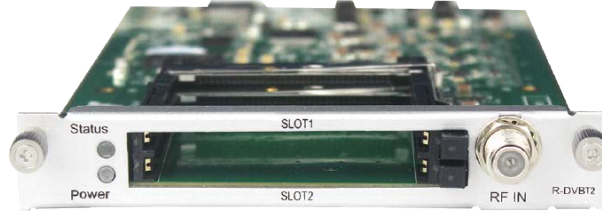

3.3.6.1 Module Status

By selecting the OHR6-DVBT2CI-00 in the module list, you will be automatically be redirected to the status page of the module. It shows the Chanel 1.1 to 1.4 that corresponds for the 4 input channels of the module. Locked Status of each channel shows the signals if these channels are locked or unlocked. If the signal is good, there will be values of Total Bitrate and Effective Bitrate.

15: CR-DVBT2-00						
Status CI Settings Service Configuration System Operation						
Channel	Locked Status	Total Bit Rate(Mbps)	Effective Bit Rate(Mbps)	RF Level	TS Analysis	Service List
1.1	Unlocked	0.000	0.000	0dBm (108dBµV)		
1.2	Unlocked	0.000	0.000	0dBm (108dBµV)		
1.3	Unlocked	0.000	0.000	0dBm (108dBµV)		
1.4	Unlocked	0.000	0.000	0dBm (108dBµV)		

Total Bit rate in Mbps shows the receiving bitrate of each channel with the LOCKED status. Effective Bit Rate in Mbps which shows the actual bitrate of each receiving channel. RF Level of the input signal will show you the level of each locked channel.

Clicking under the TS Analysis will display the information on the structure of the transport stream as shown in the picture below.

Channel 1.1 TS Analysis						
Reset Counter ✕						
<input type="text" value="Search"/> <input type="button" value="Q"/>						
PID	Bitrate(Mbps)	Bandwidth(%)	Continuity Count Error	Type	Service	
0x33(51)	0.000	0.000	0	PMT	Program-01	
0x34(52)	0.000	0.000	0	PCR	Program-01	
0x35(53)	0.000	0.000	0	Video	Program-01	
0x36(54)	0.000	0.000	0	Audio	Program-01	
0x64(100)	0.000	0.000	0	PMT	Program-01	
0x65(101)	0.000	0.000	0	PCR	Program-01	
0x66(102)	0.000	0.000	0	Video	Program-01	
0x67(103)	0.000	0.000	0	Audio	Program-01	

Tip:

Clicking under Service List will display information of the services included in the transport stream as shown in the picture below.

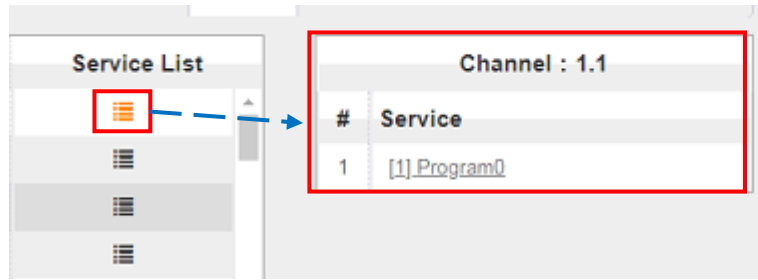

Clicking on the service name under the service will display the detailed information of the service: PCR, PMT, Video and Audio PID and Bitrate as shown in the picture below.

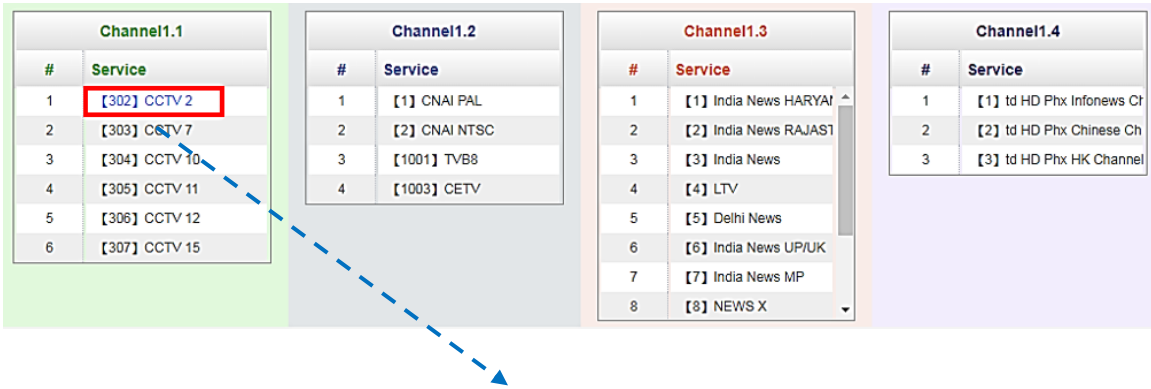

[302] CCTV 2

PID	Type	Bitrate(Mbps)
8190	PCR	0.045
258	PMT	0.018
513	StreamType:2-Video(MPEG2)	5.198
660	StreamType:4-Audio	0.262

CAM Max Bit Rate (48Mbps to 108Mbps) can be chosen in a pull-down list.

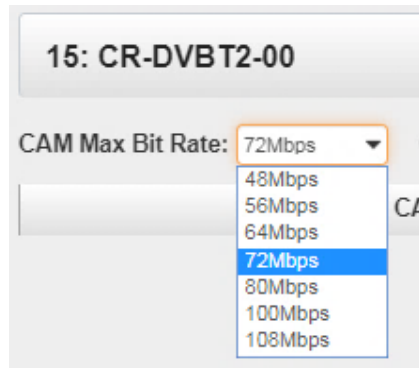

3.3.6.2 Module Settings

To input parameters of the source you want to receive in OHR6-DVBT2-00, click Settings and input the Frequency and Bandwidth. The tables below show the range of Frequency and Bandwidth for the settings parameters..

Name	Range
Frequency (KHz)	48000~862000
Bandwidth (MHz)	6, 7, 8

Channel	Frequency(KHz)	Bandwidth(MHz)
1.1	474000	8
1.2	482000	8
1.3	490000	8
1.4	498000	8

3.3.6.3 Module Service Configuration

For Service Configuration and System Operation please refer to OHR6-DVBC-00 module on page 33 to 34.

In Descrambling Settings there are CAM1, CAM2 and No Descrambling options. Select the correct CAM to decrypt the service and click Apply to make the change take effect or Clear Config button on the right side to clear all configuration.

*You need to click **Apply** button after you configure service to CAM for descrambling, otherwise the descrambling configuration will not be saved.

Service Name	Descrambling
Channel 1.1 +	
[1] LipSync_1080i	No Descrambling
Channel 1.2 +	No Descrambling
Channel 1.3 +	CAM1
Channel 1.4 +	CAM2

3.4 Encoder Modules

3.4.1 OHE6-HDMI-00/R01

OHE6-HDMI-00/R01 is a 4-channel HDMI input encoder which supports H.264 HD/SD or MPEG-2 SD encoding. The module supports MPEG1-L2, AAC and AC3 audio encoding.



3.4.1.1 Module Status

Module Status for HDMI encoder shows the Bitrate of each port when an HDMI source is connected. Video resolution of the source video will also appear in the status. Other details in status are HDCP encryption, Video Bitrate and Audio Bitrate.

OHE-HDMI-00 Status Basic Setting Output System

HDCP turned off

Program	Signal	HDCP Encryption	Video Resolution	Video Bitrate(Mbps)	Audio Bitrate(Mbps)	Total Bitrate(Mbps)	Effective Bitrate(Mbps)	TS Analy
1	✓	Unencrypted	No_Video	0.000	0.000	0.000	0.000	👁
2	✓	Unencrypted	No_Video	0.000	0.000	0.000	0.000	👁
3	✓	Unencrypted	No_Video	0.000	0.000	0.000	0.000	👁
4	✓	Unencrypted	No_Video	0.000	0.000	0.000	0.000	👁

OHE6-HDMI-00

OHE-HDMI-R01 Status Basic Setting Insertion Output System

HDCP turned on

Program	Signal	HDCP Encryption	Input Video Resolution	Output Video Resolution	Total Bitrate(Mbps)	Effective Bitrate(Mbps)	TS Analysis	Prog
1	✗	Unencrypted	No_Video	No_Video	0.000	0.000	👁	Prog
2	✗	Unencrypted	No_Video	No_Video	0.000	0.000	👁	Prog
3	✗	Unencrypted	No_Video	No_Video	0.000	0.000	👁	Prog
4	✗	Unencrypted	No_Video	No_Video	0.000	0.000	👁	Prog

OHE6-HDMI-R01

Clicking 👁 under the TS Analysis will display the information on the structure of the transport stream as shown in the picture below.

Channel 1.1 TS Analysis Reset Counter

Search

PID	Bitrate(Mbps)	Bandwidth(%)	Continuity Count Error	Type	Service
0x33(51)	0.000	0.000	0	PMT	Program-01
0x34(52)	0.000	0.000	0	PCR	Program-01
0x35(53)	0.000	0.000	0	Video	Program-01
0x36(54)	0.000	0.000	0	Audio	Program-01
0x64(100)	0.000	0.000	0	PMT	Program-01
0x65(101)	0.000	0.000	0	PCR	Program-01
0x66(102)	0.000	0.000	0	Video	Program-01
0x67(103)	0.000	0.000	0	Audio	Program-01

Tip:

3.4.1.2 Module Basic Settings

Basic Settings for both OHE6-HDMI-00 and OHE6-HDMI-R01 are the same. Here you can modify the Video, Audio and Service Parameters. Click **Advanced Setting** to see all parameters you can modify and check specific parameters you want to set and see.

Program	Video PID	Audio PID	PCR PID	PMT PID	Program Name	Provider Name
1	102	103	101	100	Program-1	Encoder
2	202	203	201	200	Program-2	Encoder
3	302	303	301	300	Program-3	Encoder
4	402	403	401	400	Program-4	Encoder

HDCP Test Mode: ON ! HDCP test mode is for test purposes only. Please make sure that you have rights for the content!

Video Parameter

- Video Encoding Format
- Video Bitrate
- Video Frame Rate
- Video Resolution
- GOP Structure
- GOP Size
- GOP Close
- Video Encode Reset
- VLC Mode
- Profile
- Level
- Video Aspect Ratio

Audio Parameter

- Audio Encoding Format
- AAC Format
- Audio Mode
- Audio Bitrate
- Audio Sampling Rate
- Volume

Service Parameter

- Program Name
- Video PID
- Audio PID
- PCR PID
- PMT PID
- Provider Name

Click the Apply button  on the right side for the changes to take effect.

Video Parameter	Range	Video Parameter	Range
Video Encoding Format	H264, MPEG2	Profile	HIGH MAIN
Video Bitrate (Kbps)	600~20000	GOP Size	6~63
Video Resolution	Auto 1920x1080_60i 1920x1080_50i 1920x1080_30p 1920x1080_25p 1080x720_60p 1080x720_50p 720x480_60i 720x576_50i	Video Aspect Ratio	Auto 16x9_LetterBox 16x9_CutOff 4x3_PillarBox 4x3_CutOff

Audio Parameter	Range	Audio Parameter	Range
Audio Encoding Format	AC3 MPEG1_Layer2 MPEG2_AAC MPEG4_AAC	Audio Bitrate (Kbps)	128~384 (AC3) 64~384(MPEG1_Layer2) 32~384(MPEG2_AAC/ MPEG4_AAC)
Delay	Dual Channel Mono Stereo	Volume	0~8

OHE-HDMI-R01 is basically the same with OHE-HDMI-00 except a few differences on the parameter setting range.

Service Parameter	Range	Service Parameter	Range
Program Name	Length is 1~16	Audio PID	32~8190
Provider Name	Length is 1~16	PCR PID	32~8190
Video PID	32~8190	PMT PID	32~8190

OHE-HDMI-R01 Status **Basic Setting** Insertion Output System

Advanced Setting >

Program	Video Encoding Format	Video Bitrate(Kbps)
1	H.264	8000
2	H.264	8000
3	H.264	8000
4	H.264	8000

HDPC Test Mode : ON HDPC test mode is for test purposes only. Please make sure that you have rights for the content!

Advanced Setting ▾

Video Parameter

- Video Encoding Format
- Video Resolution
- Video Bitrate
- GOP Size
- Profile
- Video Aspect Ratio

Audio Parameter

- Audio Encoding Format
- Delay
- Audio Bitrate
- Volume

Service Parameter

- Program Name
- Video PID
- Audio PID
- PCR PID
- PMT PID
- Provider Name

Shelter Parameter

- X
- Y
- Width
- Height
- Color
- Shelter

Video Parameter	Range	Video Parameter	Range
Video Type	H264	Profile	HIGH MAIN
Video Resolution	Auto, 1920x1080_60i ,	GOP Size	1~60

	1920x1080_50i , 1920x1080_30p , 1920x1080_25p , 1080x720_60p , 1080x720_50p , 720x480_60i , 720x576_50i		
Video Bitrate (Kbps)	600~12000	Video Aspect Ratio	16x9 (HD) 4x3 (SD)

Audio Encoder Details	Range	Audio Encoder Details	Range
Audio Type	MPEG1_Layer2 AC3 AAC	Volume (dB)	-20~20
Delays (ms)	-2000~2000	Audio Bit rate (Kbps)	32~192 (MPEG1_Layer2 / AAC) 96~192 (AC3)

Shelter Parameters	Range	Shelter Parameters	Range
Shelter	Enable/Disable	X	0~1920 (Dual)
Y	0~1080 (Dual)	Width	2~1920 (Dual)
Height	2~1080 (Dual)	Color	White/Black/Blue/Green/Red

3.4.1.3 Output

For the Output, both models have direct IP output and multiplexing. But only OHE6-HDMI-R01 has RTMP output settings.

Direct IP output is specifically for encoding a single program and outputting it directly to IP. This setting will not occupy multicast bandwidth baseboard.

 If you want to use IP output channel on the encoder module and the baseboard IP module at same time, you should avoid the multicast IP addresses conflicts. If there are two same IP addresses enabled meantime, all the multicast videos will be affected.

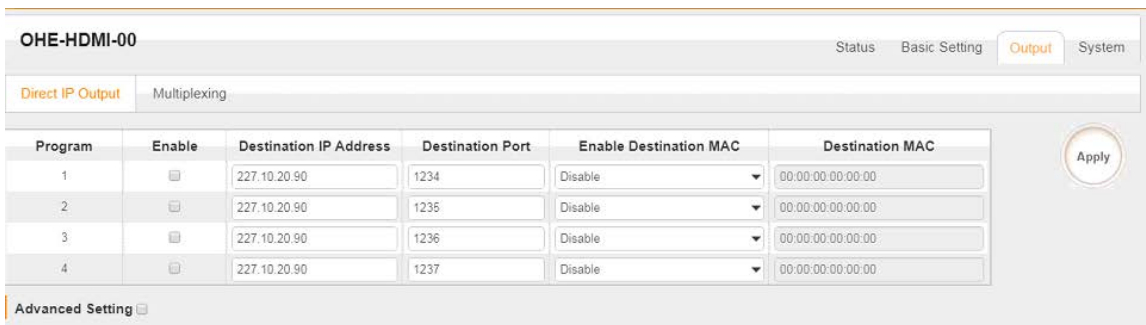

OHE6-HDMI-00

Status Basic Setting **Output** System

Direct IP Output Multiplexing

Program	Enable	Destination IP Address	Destination Port	Enable Destination MAC	Destination MAC
1	<input type="checkbox"/>	227.10.20.90	1234	Disable	00:00:00:00:00:00
2	<input type="checkbox"/>	227.10.20.90	1235	Disable	00:00:00:00:00:00
3	<input type="checkbox"/>	227.10.20.90	1236	Disable	00:00:00:00:00:00
4	<input type="checkbox"/>	227.10.20.90	1237	Disable	00:00:00:00:00:00

Advanced Setting

Apply

OHE6-HDMI-00

OHE-HDMI-R01 Status Basic Setting Insertion **Output** System

Direct IP Output **Multiplexing** RTMP Output

Program	Enable	Destination IP Address	Destination Port	Enable Destination MAC	Destination MAC
1	<input checked="" type="checkbox"/>	227.10.20.90	1234	Disable	01:00:5E:0A:14:5A
2	<input checked="" type="checkbox"/>	227.10.20.90	1235	Disable	01:00:5E:0A:14:5A
3	<input checked="" type="checkbox"/>	227.10.20.90	1236	Disable	01:00:5E:0A:14:5A
4	<input checked="" type="checkbox"/>	227.10.20.90	1237	Disable	01:00:5E:0A:14:5A

OHE6-HDMI-R01

- **Destination IP Address** and **Destination Port**: for multicast IP addresses or unicast IP addresses and ports.
- **Enable Destination MAC**: Generally, you do not need to enable this option. This is reserved for exceptional cases when the unicast stream cannot be received with the unicast IP addresses. You can enable destination MAC and streaming out by setting Destination MAC.
- **Advance Setting (only available in OHE6-HDMI-00)**:

Advance Settings

Enable the second eth:

IP Address	Subnet Mask	Default Gateway	MAC Address
192.168.131.45	255.255.255.0	192.168.131.254	A0:69:86:02:42:C7

The second eth is reserved to output IP streams in an another different VLAN. Enabling the second eth and set **IP Address**, **Subnet Mask**, **Default Gateway** in the same segment of the Unicast IP (the another different VLAN), you can output the Unicast stream to the another VLAN.

Direct IP Output **Multiplexing** RTMP Output

#	Service Name	Destination	Destination Setting
1	[1] Program-01		
2	[1] Program-02		
3	[1] Program-03		
4	[1] Program-04		

To use **Multiplexing mode on service level**

1. Click on (pencil) icon. There will always be a BaseBoard selection for the IP output and other Output option depending on the modules inserted.
2. Select the correct Output and Channel you want to output the Service.
3. Check Multiplex for the Channel you want to output,. You can output multiple services in same channel or output same service in multiple channels.

Direct IP Output		Multiplexing		RTMP Output					
Program	Enable	FMS URL	Stream Name	Port	Encrypt	User Name	Password	Status	
1	<input type="checkbox"/>	rtmp://172.16.1.254/live	live_stream0	1935	Disable	admin	admin	Connection Fail	
2	<input type="checkbox"/>	rtmp://172.16.1.254/live	live_stream1	1935	Disable	admin	admin	Connection Fail	
3	<input type="checkbox"/>	rtmp://172.16.1.254/live	live_stream2	1935	Disable	admin	admin	Connection Fail	
4	<input type="checkbox"/>	rtmp://172.16.1.254/live	live_stream3	1935	Disable	admin	admin	Connection Fail	

To use RTMP output to configure streaming to any website capable of receiving RTMP, it is necessary to create a new stream instance on the intended receiving platform and enter the corresponding URL and port.

3.4.1.4 Insertion (only available in the OHE6-HDMI-R01 module)

You should choose a channel first before you set Insertion.

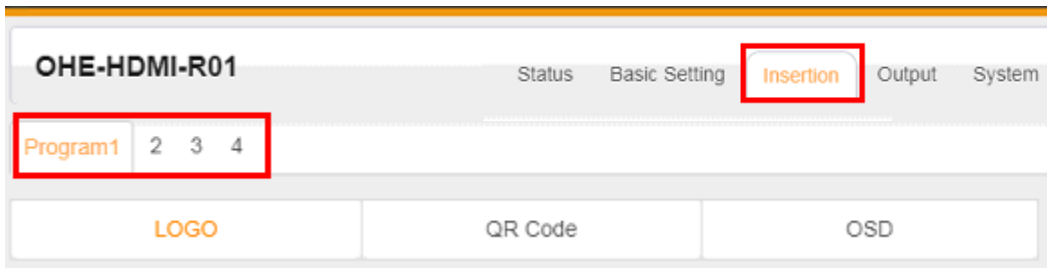

- **LOGO setting:** you can upload several pictures at the same time, and pick one to show on the screen. When you click the one you want to show that picture field will turn green.

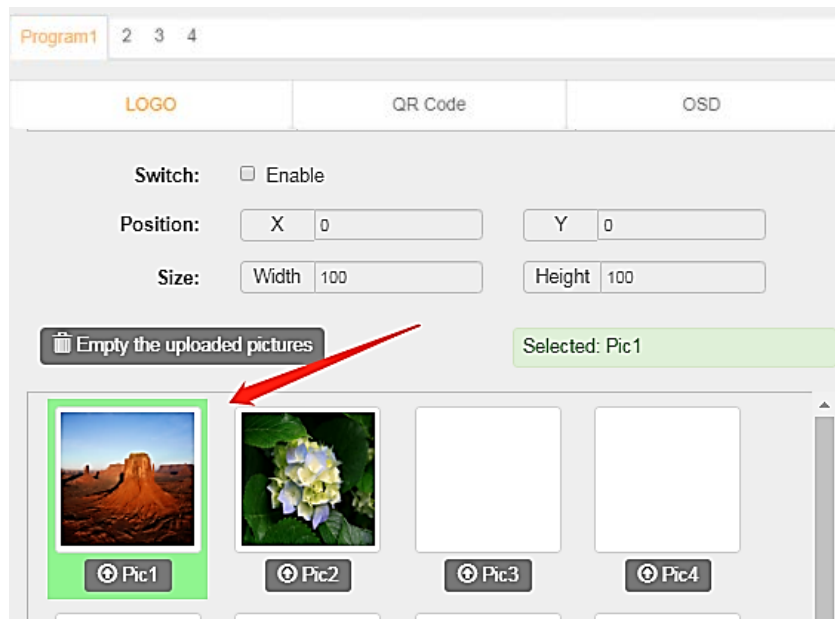

LOGO Parameter	Range	LOGO Parameter	Range
Position X	0~1920 (Dual)	Position Y	0~1080 (Dual)
Size width	0~1920 (Dual)	Size Height	0~1080 (Dual)

- Subtitle setting:

Subtitle Parameter	Range	LOGO Parameter	Range
Position	Bottom/Top/Middle	Size width	0~1920 (Dual)
Size Height	0~1080 (Dual)	Front	0~100

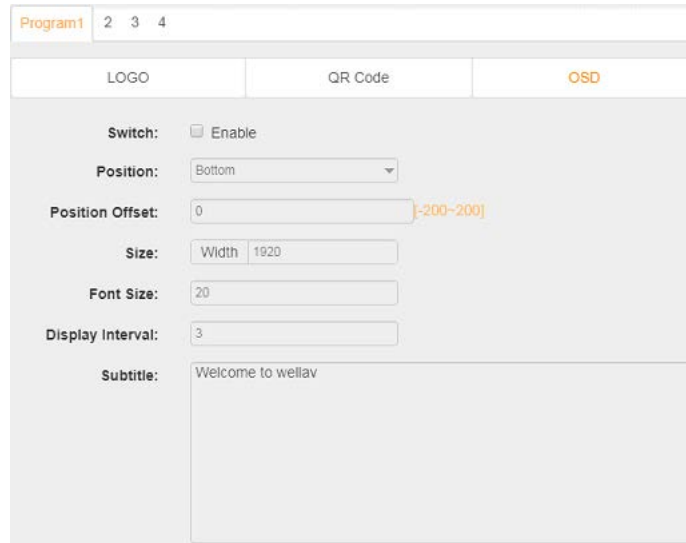

- QR Code setting: QR Code picture selection is same with LOGO setting.

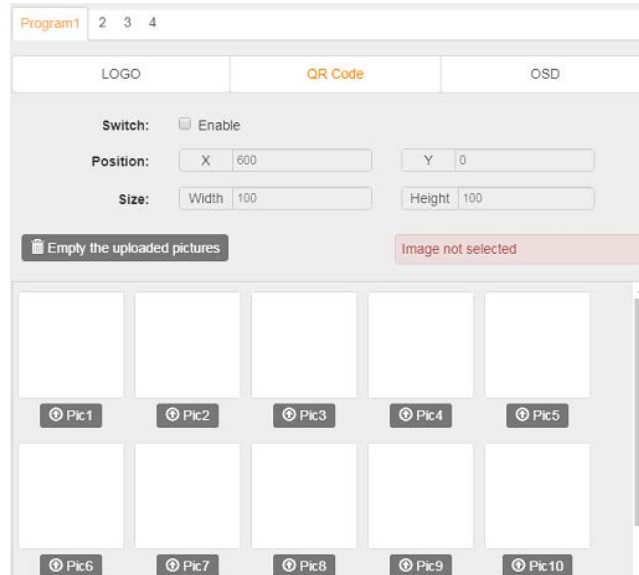

LOGO Parameter	Range	LOGO Parameter	Range
Position X	0~1920 (Dual)	Position Y	0~1080 (Dual)
Size width	0~1920 (Dual)	Size Height	0~1080 (Dual)

3.4.1.5 System

System tab allows you to perform the following tasks:

- Import / export license
- Log manages
- Reboot
- Factory Default

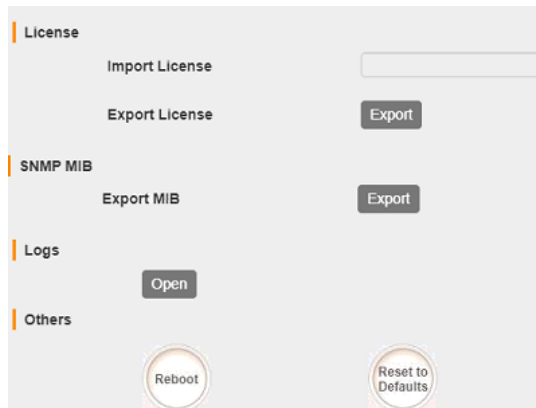

To open the log management menu, click on the **Open** button. The newly opened menu allows you to enable / disable logging.

After login is enabled, additional control buttons will be displayed:

- clean log, clean screen, export logs, filter dialog box

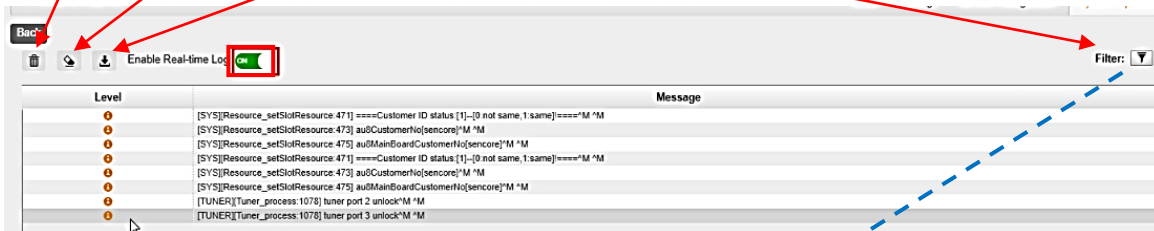

Filter

Level	
Level	Operation
Error	<input checked="" type="checkbox"/>
Warning	<input checked="" type="checkbox"/>
Information	<input checked="" type="checkbox"/>
Debug	<input type="checkbox"/>

Module List	
Module Name	Operation
SYS	<input checked="" type="checkbox"/>
PARAMS	<input checked="" type="checkbox"/>
UPGRADE	<input checked="" type="checkbox"/>
TSPROCESS	<input checked="" type="checkbox"/>
SIPROCESS	<input checked="" type="checkbox"/>
LICENSE	<input checked="" type="checkbox"/>

3.4.2 OHE6-HDMI-02

OHE6-HDMI-02 is a 2-channel HDMI encoder which supports H.264 HD/SD or MPEG-2 HD/SD encoding with 2-channel RCA for CC input. The module supports MPEG1-L2, AAC and AC3 audio encoding.



3.3.5.1 Module Status

Module Status for the HDMI encoder shows the Bitrate of each port when an HDMI source is connected. The Status for OHE6-HDMI-02 is the same with OHE6-HDMI-00. The differences are the number of channels shown in the status and some other parameters for example, OHE6-HDMI-00 doesn't have Audio2 Bitrate and the input/output video resolution.

OHE-HDMI-02							
Status Basic Setting Output EAS Setting System							
HDCP turned off							
Program	Signal	HDCP Encryption	Input Video Resolution	Output Video Resolution	Video Bitrate(Mbps)	Audio1 Bitrate(Mbps)	Audio2 Bitrate(Mbps)
1	✘	Unencrypted	No_Video	No_Video	0.000	0.000	off
2	✘	Unencrypted	No_Video	No_Video	0.000	0.000	off

3.4.2.2 Module Basic Settings

Click **Advanced Setting** to see all parameters you can modify and check specific parameters you want to set and see. Click the **Apply** button on the right side to make the change take effect.

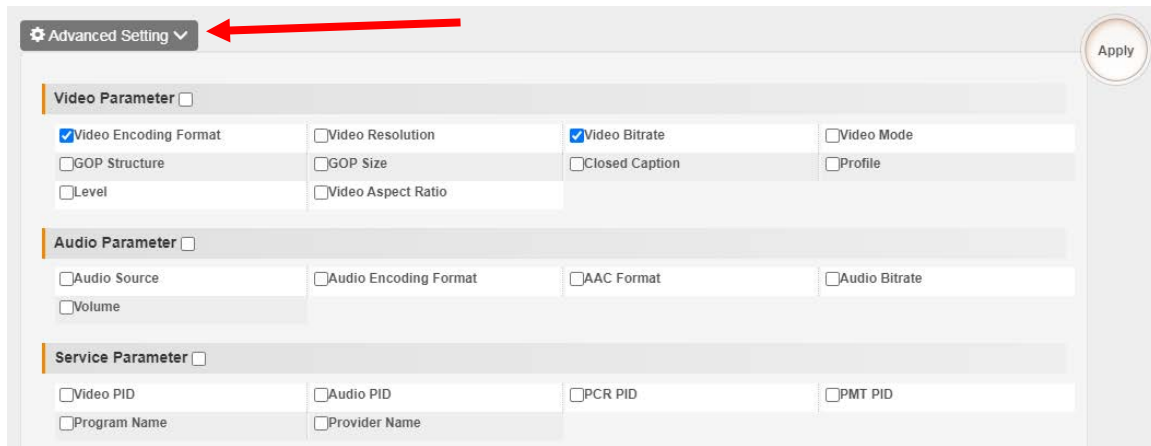
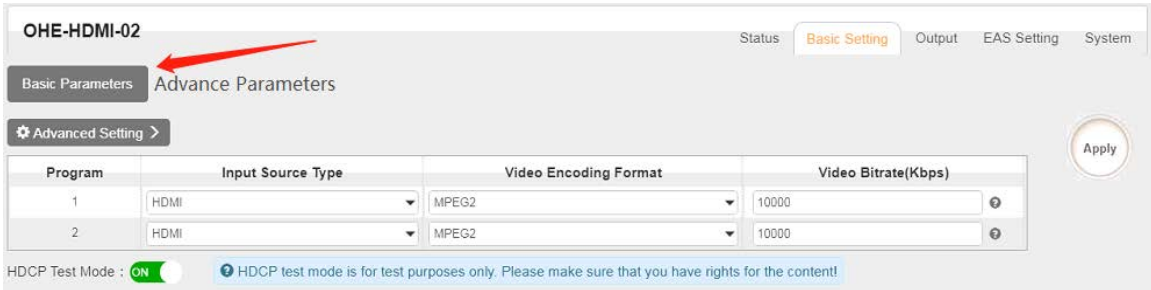

Video Parameter	Range	Video Parameter	Range
Video Encoding Format	H264, MPEG2	GOP Size	12~48
Video Resolution	Auto, 1920x1080_60i, 1920x1080_50i, 1920x1080_30p, 1920x1080_25p, 1080x720_60p, 1080x720_50p, 720x480_60i, 720x576_50i	Level	Level_3.0, Level_3.1, Level_3.2, Level_4.0, Level_4.1, Level_4.2
Video Bitrate (Kbps)	100 and 18000	Profile	High, Main, Baseline
Video Mode	CBR	Closed Caption	Enable, Disable
GOP Structure	IBBP, IPPP, IBP	Video Aspect Ratio	Auto, 16x9, 4x3

Audio Encoder Details	Range	Audio Encoder Details	Range

Audio Encoding Format	AC3 AC3_Passthrough MPEG1_Layer2 MPEG2_AAC MPEG4_AAC AAC_HE_V2	Audio Bitrate (Kbps)	128~384 (AC3) 64~384(MPEG1_Layer2) 64~384(MPEG2_AAC/ MPEG4_AAC) 32~384 (AAC_HE_V2)
Audio Source	HDMI	Volume (dB)	0~8
AAC Format	ADTS, LATM		

Service Parameter	Range	Service Parameter	Range
Program Name	String between 1~31	Audio PID	32~8190
Provider Name	String between 0~31	PCR PID	32~8190
Video PID	32~8190	PMT PID	32~8190

The OHE6-HDMI-02 module supports two sets of audio and video input. Each set includes 1 HDMI port/1 component port and 1 analog port. It supports dual audio encoding per channel. Dual audio all come from HDMI input with the same content and the encoding format can be the same or different.

3.4.2.3 Module Output

Direct IP output is specifically for encoding a single program and outputting it directly to IP. This setting will not occupy multicast bandwidth of the baseboard.



If you want to use IP output channel on the encoder module and the baseboard IP module at same time, you should avoid the multicast IP addresses conflicts. If there are two same IP addresses enabled meantime, all the multicast videos will be affected.

- **Destination IP Address and Destination Port:** for multicast IP addresses or unicast IP addresses and ports.
- **Enable Destination MAC:** Generally, you do not need to enable this option. This is reserved for exceptional cases when the unicast stream cannot be received by with the unicast IP addresses. You can enable destination MAC and streaming out by setting Destination MAC.

To use **Multiplexing mode on service level**

1. Click on ✎ (pencil) icon. There will always be a BaseBoard selection for the IP output and other Output options depending on the module inserted.
2. Select the correct Output and Channel you want to output the service to.
3. Check Multiplex on the channel you want to output. You can output multiple services to one channel or output one service to multiple channels.

3.4.2.4 EAS Settings

When the EAS source is triggered, the Audio and Video from the encoder will be replaced by the Audio and Video from the EAS module.

On this page, you need to input the EAS Source Multicast Address, Command port and Data port. This information can be seen on the EAS page.

EAS Source Multicast Address: <input type="text" value="227.10.50.60"/>		Command Port: <input type="text" value="1235"/>	Data Port: <input type="text" value="1234"/>
Program	Program Name	Status	EAS Override: <input checked="" type="checkbox"/>
1	Program-1	Not Paved	<input checked="" type="checkbox"/>
2	Program-2	Not Paved	<input checked="" type="checkbox"/>

3.4.2.5 System

System tab allows you to perform the following tasks:

- Import / export license
- Log manages
- Reboot
- Factory Default

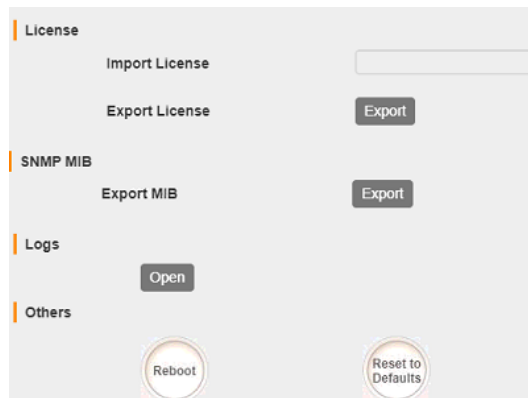

To open the log management menu, click on the **Open** button. The newly opened menu allows you to enable / disable logging.

After login is enabled, additional control buttons will be displayed:
 - clean log, clean screen, export logs, filter dialog box

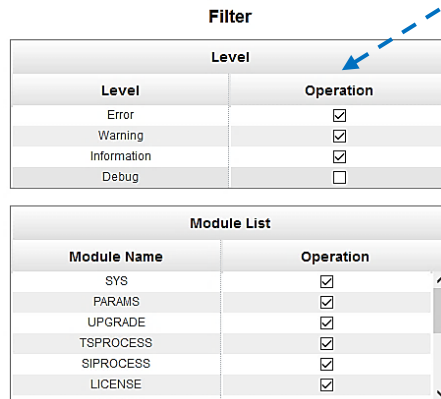
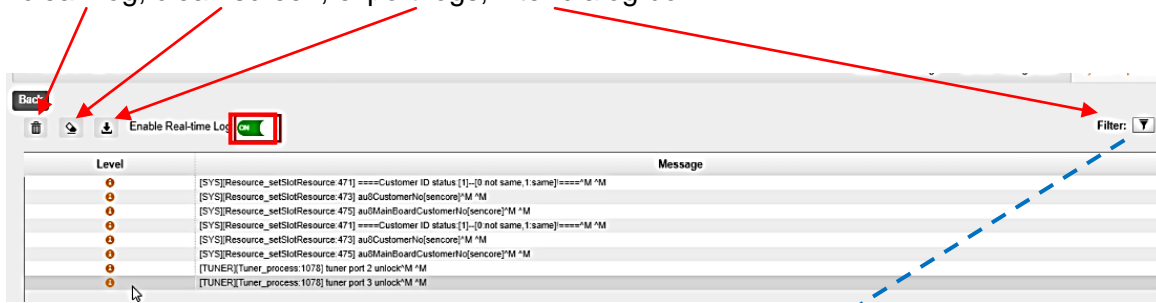

3.4.3 OHE6-HDMI-02C

OHE6-HDMI-02C is a 2-channel HDMI or component HD encoder. It supports H.264 / MPEG-2 HD/SD, MPEG1L2, AAC (optional), AC3 (optional) audio, CC subtitle and analog audio input.



3.4.3.1 Module Status

Module Status for HDMI-02C encoder shows the Bitrate of each port when an HDMI source is connected. Video resolution of the source video will also appear on the status.

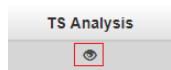

Clicking on the  button will display information on the structure of the transport stream. This will show more details about the Service in the channel depending on the parameters you set on the Module Setting.

HDCP turned off							
Program	Signal	HDCP Encryption	Input Video Resolution	Output Video Resolution	Video Bitrate(Mbps)	Audio1 Bitrate(Mbps)	Audio2 Bitrate(Mbps)
1	✘	Unencrypted	No_Video	No_Video	0.000	0.000	off
2	✘	Unencrypted	No_Video	No_Video	0.000	0.000	off

3.4.3.2 Module Basic Settings

In module Setting, there are Basic and Advanced parameters.

In Basic Parameters, here you can edit or modify Video parameters (resolution, GOP, etc.), audio parameters (bitrate, volume, etc.) and service parameters (PID of Video, audio, PMT etc.)

Click **Advanced Setting** to see all parameters you can modify and check specific parameters you want to set and see. Click the Apply button on the right side to make the changes take effect.

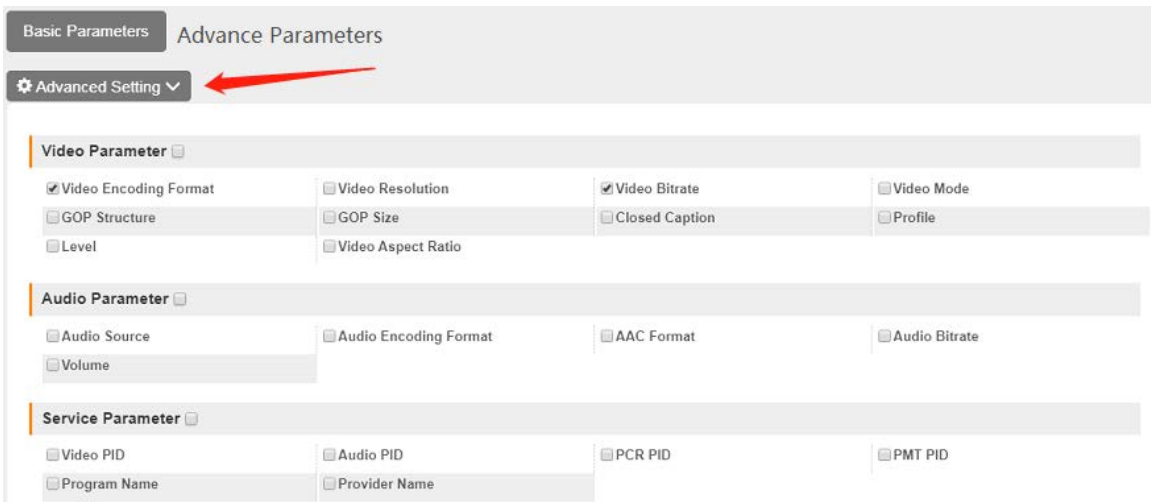

Click **Advanced Setting** in the line to set encoding parameters.

Video Parameter	Range	Video Parameter	Range
Video Encoding Format	H264, MPEG2	GOP Size	12~48
Video Resolution	Auto, 1920x1080_60i, 1920x1080_50i, 1920x1080_30p, 1920x1080_25p, 1080x720_60p, 1080x720_50p, 720x480_60i, 720x576_50i	Level	Level_3.0, Level_3.1, Level_3.2, Level_4.0, Level_4.1, Level_4.2
Video Bitrate (Kbps)	100 and 18000	Profile	High, Main, Baseline
Video Mode	CBR	Closed Caption	Enable, Disable
GOP Structure	IBBP, IPPP, IBP	Video Aspect Ratio	Auto, 16x9

			4x3
--	--	--	-----

Audio Encoder Details	Range	Audio Encoder Details	Range
Audio Encoding Format	AC3 AC3_Passthrough MPEG1_Layer2 MPEG2_AAC MPEG4_AAC AAC_HE_V2	Audio Bitrate (Kbps)	128~384 (AC3) 64~384(MPEG1_Layer2) 64~384(MPEG2_AAC/ MPEG4_AAC) 32~384 (AAC_HE_V2)
Audio Source	HDMI, Analog	Volume (dB)	0~8
AAC Format	ADTS, LATM		

Service Parameter	Range	Service Parameter	Range
Program Name	String between 1~31	Audio PID	32~8190
Provider Name	String between 0~31	PCR PID	32~8190
Video PID	32~8190	PMT PID	32~8190

The OHE6-HDMI-02C module supports two sets of audio and video input in total. Each set includes 1 HDMI port/1 component port and 1 analog port.

If the video comes from HDMI, there are three options for encoding dual audio:

1. One audio comes from HDMI and the other comes from analog; the encoding format can be the same or different.
2. Dual audio all come from HDMI with the same content and the encoding format can be the same or different.
3. Dual audio all come from the analog input with the same content and the encoding format can be the same or different.

If the video comes from the component, there is only one choice for encoding dual audio:

Dual audio all come from the analog input with the same content and the encoding format can be the same or different.

3.4.4.3 IP Output

This feature is specifically for encoding a single program and outputting it directly to IP. It will not occupy multicast bandwidth of the baseboard.







If you want to use IP output channel on the encoder module and the baseboard IP module at the same time, you should avoid the multicast IP address conflicts. If there are two same IP addresses enabled meantime, all the multicast videos will be affected.

- **Destination IP Address** and **Destination Port:** for multicast IP addresses or unicast IP addresses and ports.
- **Enable Destination MAC:** Generally, you do not need to enable this option. This is reserved for exceptional cases when the unicast stream cannot be received using unicast IP addresses. You can enable destination MAC and streaming out by setting Destination MAC.

Direct IP Output		Multiplexing			
Program	Enable	Destination IP Address	Destination Port	Enable Destination MAC	Destination MAC
1	<input checked="" type="checkbox"/>	227.10.20.90	1234	Disable	00:00:00:00:00:00
2	<input type="checkbox"/>	227.10.20.90	1235	Disable	00:00:00:00:00:00

To use **Multiplexing mode on service level**:

1. Click on  (pencil) icon. There will always be a BaseBoard selection for the IP output and other Output options depending on the module inserted.
2. Select the correct Output and Channel you want to output the service to.
3. Check Multiplex on the channel you want to output. You can output multiple services to one channel or output one service to multiple channels.

Direct IP Output		Multiplexing	
#	Service Name	Destination	Destination Setting
1	[1] Program-01		
2	[1] Program-02		
3	[1] Program-03		
4	[1] Program-04		

3.4.3.4 EAS Settings

When the EAS source is triggered, the Audio and Video from the encoder will be replaced by the Audio and Video from the EAS module.

EAS Source Multicast Address:	235.1.1.100	Command Port:	10000	Data Port:	10001
Program	Program Name	Status	EAS Override: <input checked="" type="checkbox"/>		
1	Program-1	Not Paved	<input checked="" type="checkbox"/>		
2	Program-2	Not Paved	<input checked="" type="checkbox"/>		

3.4.3.5 System Operation

System tab allows you to perform the following tasks:

- Import / export license
- Log manages
- Reboot
- Factory Default

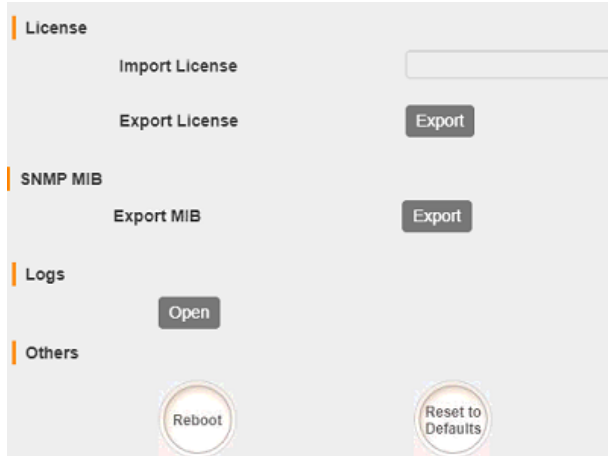

To open the log management menu, click on the **Open** button. The newly opened menu allows you to enable / disable logging.

After login is enabled, additional control buttons will be displayed:

- clean log, clean screen, export logs, filter dialog box

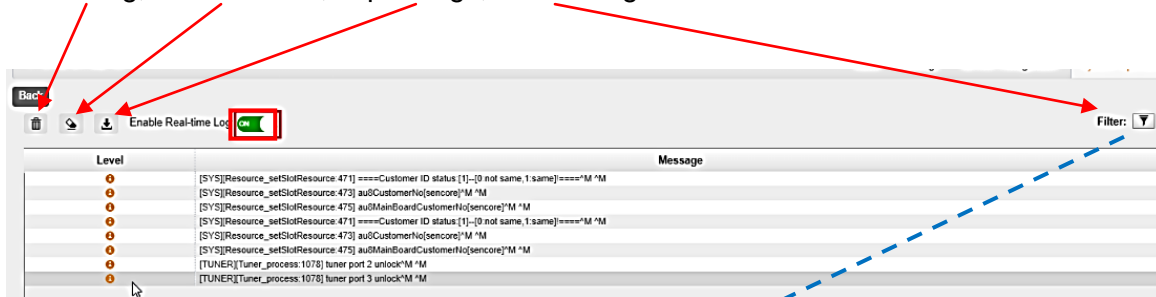

Filter

Level	
Level	Operation
Error	<input checked="" type="checkbox"/>
Warning	<input checked="" type="checkbox"/>
Information	<input checked="" type="checkbox"/>
Debug	<input type="checkbox"/>

Module List	
Module Name	Operation
SYS	<input checked="" type="checkbox"/>
PARAMS	<input checked="" type="checkbox"/>
UPGRADE	<input checked="" type="checkbox"/>
TSPROCESS	<input checked="" type="checkbox"/>
SIPROCESS	<input checked="" type="checkbox"/>
LICENSE	<input checked="" type="checkbox"/>

3.4.4 OHE6-HDMI-05/05A

OHE6-HDMI-05/05A module is a 4/8 - channel HDMI encoding module that supports H.264. This supports AC3 and AAC via license and supports OSD Subtitle, logo picture

and QR code overlay. OHE6-HDMI-05 occupies 1 slot in the chassis and OHE6-HDMI-05A occupies 2 slots in OmniHub 6/6D chassis.

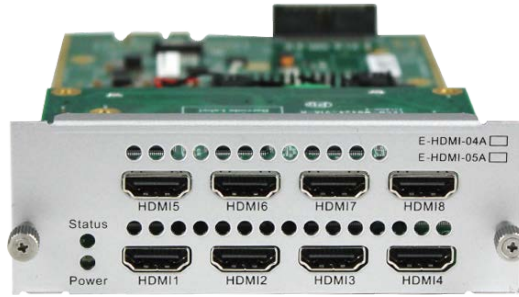

3.4.4.1 Module Status

Like other Hdmi encoder module. The Status of OHE6-HDMI-05/05A shows the Bitrate, input and output Resolution, TS analysis and Service List on each channel as shown in the image below.

OHE-HDMI-05A								
Status Basic Setting Insertion Output System								
HDCP turned on								
Program	Signal	HDCP Encryption	Input Video Resolution	Output Video Resolution	Total Bitrate(Mbps)	Effective Bitrate(Mbps)	TS Analysis	Prog
1	✘	Unencrypted	No_Video	No_Video	0.000	0.000	👁	Pro
2	✘	Unencrypted	No_Video	No_Video	0.000	0.000	👁	Pro
3	✘	Unencrypted	No_Video	No_Video	0.000	0.000	👁	Pro
4	✘	Unencrypted	No_Video	No_Video	0.000	0.000	👁	Pro
5	✘	Unencrypted	No_Video	No_Video	0.000	0.000	👁	Pro
6	✘	Unencrypted	No_Video	No_Video	0.000	0.000	👁	Pro
7	✘	Unencrypted	No_Video	No_Video	0.000	0.000	👁	Pro
8	✘	Unencrypted	No_Video	No_Video	0.000	0.000	👁	Pro

3.4.4.2 Module Basic Settings

This page allows you to modify the Video, Audio and Service Parameters. Click **Advanced Settings** to see all parameters you can modify and check specific parameters you want to set and see. Click the **Apply** button on the right side to make the change take effect.

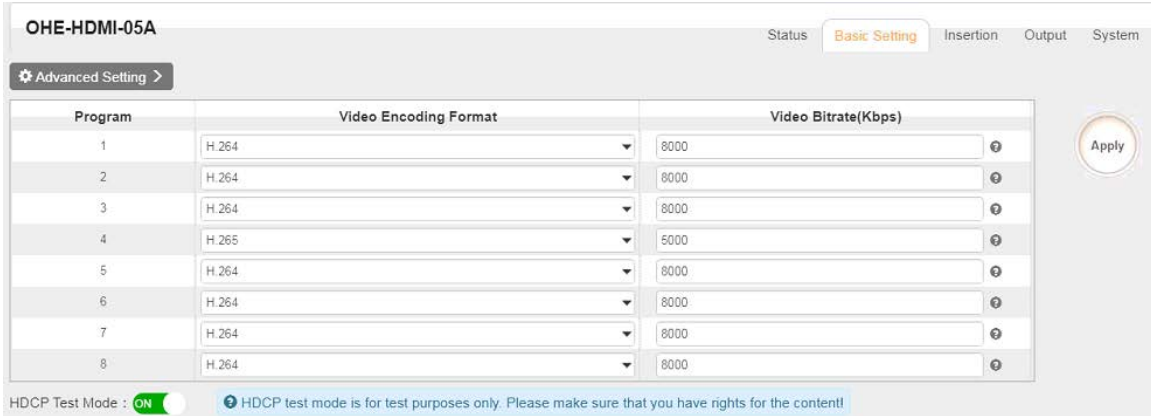

3.4.4.3 Module Insertion Settings

You should choose a channel first before you set Insertion.

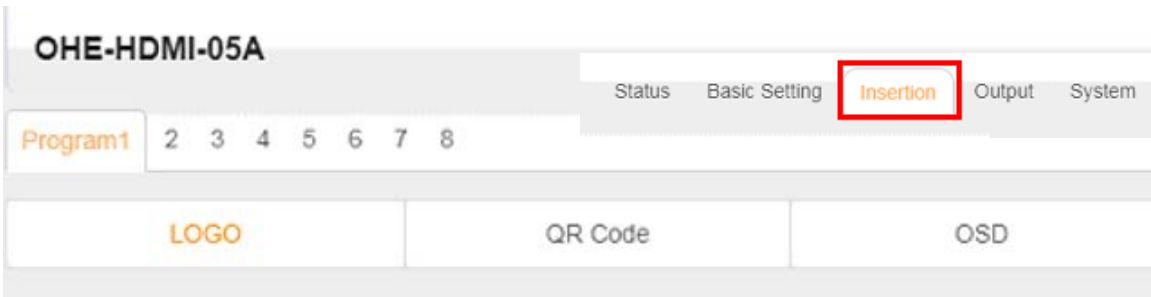

- **LOGO setting:** you can upload several pictures at the same time, and pick one to show on the screen. When you click the one you want to show that picture field will turn green.

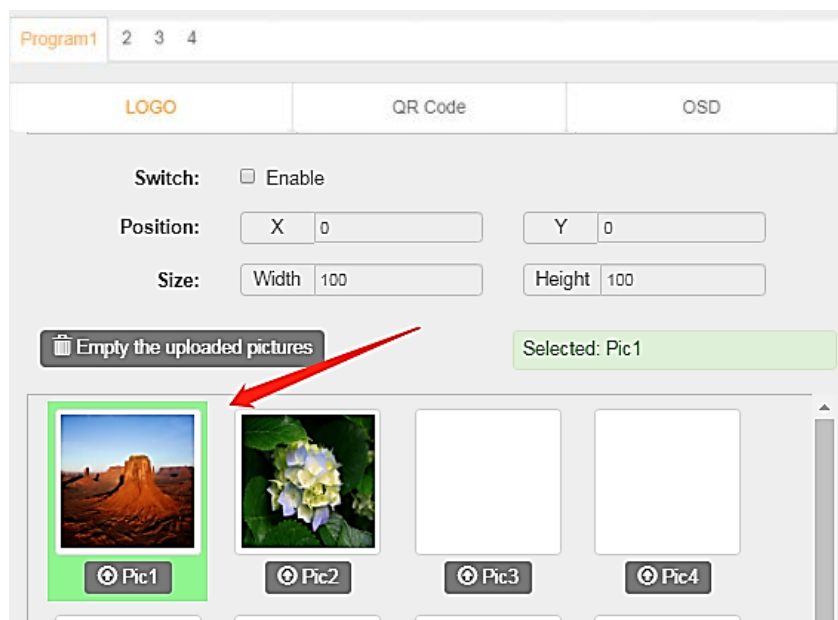

LOGO Parameter	Range	LOGO Parameter	Range
Position X	0~1920 (Dual)	Position Y	0~1080 (Dual)
Size width	0~1920 (Dual)	Size Height	0~1080 (Dual)

- Subtitle setting:

Subtitle Parameter	Range	LOGO Parameter	Range
Position	Bottom/Top/Middle	Size width	0~1920 (Dual)
Size Height	0~1080 (Dual)	Front	0~100

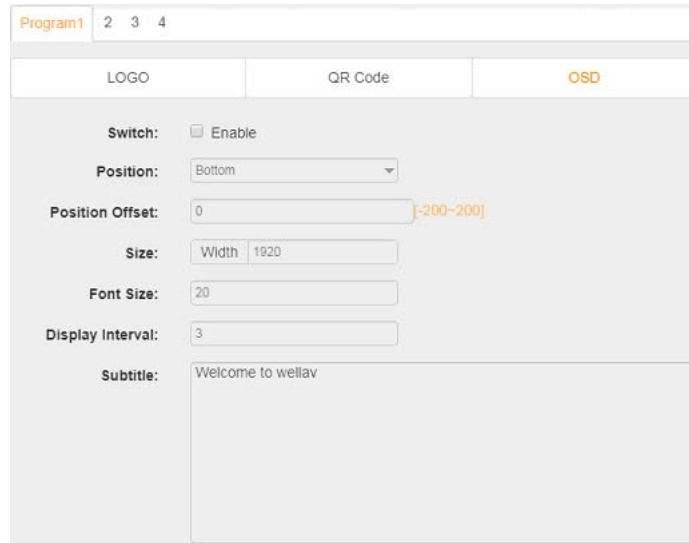

- QR Code setting: QR Code picture selection is same to LOGO setting.

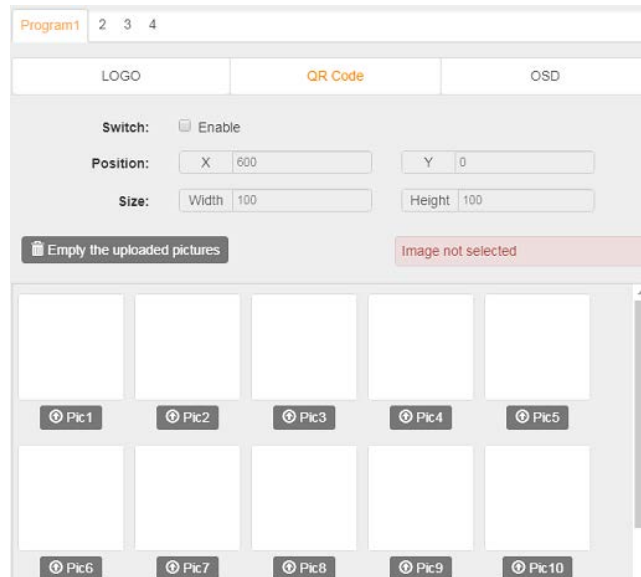

LOGO Parameter	Range	LOGO Parameter	Range
Position X	0~1920 (Dual)	Position Y	0~1080 (Dual)
Size width	0~1920 (Dual)	Size Height	0~1080 (Dual)

3.4.4.4 Module IP Output

This feature is specifically for encoding a single program and outputting directly to IP. It will not occupy multicast bandwidth of baseboard.



If you want to use IP output channel on the encoder module and the baseboard IP module at the same time, you should avoid the multicast IP address conflicts. If there are two same IP addresses enabled meantime, all the multicast videos will be affected.

OHE-HDMI-05A Status Basic Setting Insertion **Output** System

Direct IP Output Multiplexing

Program	Enable	Destination IP Address	Destination Port	Enable Destination MAC	Destination MAC
1	<input type="checkbox"/>	227.20.20.95	1234	Disable	01:00:5E:14:14:5F
2	<input type="checkbox"/>	227.10.20.90	1235	Disable	00:00:00:00:00:00
3	<input type="checkbox"/>	227.10.20.90	1236	Disable	00:00:00:00:00:00
4	<input checked="" type="checkbox"/>	227.10.20.90	1237	Disable	01:00:5E:0A:14:5A
5	<input type="checkbox"/>	227.10.20.90	1238	Disable	00:00:00:00:00:00
6	<input type="checkbox"/>	227.10.20.90	1239	Disable	00:00:00:00:00:00
7	<input type="checkbox"/>	227.10.20.90	1240	Disable	00:00:00:00:00:00
8	<input type="checkbox"/>	227.10.20.90	1241	Disable	00:00:00:00:00:00

Apply

- **Destination IP Address and Destination Port:** for multicast IP addresses or unicast IP addresses and ports.
- **Enable Destination MAC:** Generally, you do not need to enable this option. This is reserved for exceptional cases when the unicast stream cannot be received with using unicast IP addresses. You can enable destination MAC and streaming out by setting Destination MAC.

Direct IP Output **Multiplexing**

! There are unapplied settings, please click the apply button to apply your settings!

Program	Program Name	Destination	Destination Setting
1	Program-01	3.OHM-OFDM-R01[1.1]	✎
2	Program-02		✎
3	Program-03		✎
4	Program-04		✎

Apply
Clear Config

To use **Multiplexing mode on service level:**

1. Click on ✎ (pencil) icon. There will always be a BaseBoard selection for the IP output and other Output options depending on the module inserted.
2. Select the correct Output and Channel you want to output the service to.
3. Check Multiplex on the channel you want to output. You can output multiple services to one channel or output one service to multiple channels.

3.4.5 OHE6-SDI-00

OHE6-SDI-00 module supports 2 CH of H.264/AVC HD/SD (up to 1080p60) or MPEG-2 HD/SD (up to 1080i60) encoding via SDI/CVBS input. MPEG1-L2, AAC and AC3 audio encoding are available with optional licenses, 2x BNC, 2x6-pins interfaces for analog audio inputs



3.4.5.1 Module Status

Status page for OHE6-SDI shows the following parameters: Signal Status, Input Video Resolution, Output Video Resolution, Video Bitrate, Audio Bitrate, Audio2 Bitrate, Total Bitrate, Effective Bitrate, TS analysis and Program Name. The following parameters will display values once a good SDI source is connected.

OHE-SDI-00								
Status Basic Setting Output EAS Setting System								
Program	Signal	Input Video Resolution	Output Video Resolution	Video Bitrate(Mbps)	Audio1 Bitrate(Mbps)	Audio2 Bitrate(Mbps)	Total Bitrate(Mbps)	Effective Bitrate(Mbps)
1	✘	No_Video	No_Video	0.000	0.000	off	0.000	0.000
2	✘	No_Video	No_Video	0.000	0.000	off	0.000	0.000

3.4.5.2 Module Basic Settings

The Setting for SDI has Basic and Advanced Parameters. Basic Parameters are the same with the other Encoder Parameters where we can modify the Video, Audio and Service Parameters as shown in the picture below.

OHE-SDI-00			
Status Basic Setting Output System			
Basic Parameters			
⚙️ Advanced Setting > Apply			
Program	Input Source Type	Video Encoding Format	Video Bitrate(Kbps)
1	SDI	MPEG2	10000
2	SDI	MPEG2	10000

Advanced parameters will display the list of parameters that you can enable and modify.

Basic Parameters

Advanced Setting

Video Parameter

Video Encoding Format Video Resolution Video Bitrate Video Mode

GOP Structure GOP Size Closed Caption Profile

Level Video Aspect Ratio

Audio Parameter

Audio Source Audio Encoding Format AAC Format Audio Bitrate

Volume

Service Parameter

Video PID Audio PID PCR PID PMT PID

Program Name Provider Name

Apply

Program	Input Source Type	Video Encoding Format	Video Bitrate(Kbps)	Audio1:PID	Audio2:PID	Video PID	Program Name
1	SDI	MPEG2	10000	103	104	101	Program-1
2	SDI	MPEG2	10000	203	204	201	Program-2

Video Parameter	Range	Video Parameter	Range
Video Encoding Format	H264, MPEG2	GOP Size	12~48
Video Resolution	Auto, 1920x1080_60i , 1920x1080_50i , 1920x1080_30p , 1920x1080_25p , 1080x720_60p , 1080x720_50p , 720x480_60i , 720x576_50i	Level	Level_1,0 Level_1B Level_1.1 Level_1.2 Level_1.3 Level_2.0 Level_2.1 Level_2.2 Level_3.0 Level_3.1 Level_3.2 Level_4.0 Level_4.1 Level_4.2
Video Bitrate (Kbps)	100 ~18000	Profile	High, Main, Baseline
Video Mode	CBR	Closed Caption	Enable, Disable
GOP Structure	IBBP, IPPP, IBP, I	Video Aspect Ratio	Auto 16x9 4x3

Audio Encoder Details	Range	Audio Encoder Details	Range
Audio Encoding Format	AC3 AC3_Passthrough MPEG1_Layer2 MPEG2_AAC MPEG4_AAC	Audio Bitrate (Kbps)	128~384 (AC3) 64~384(MPEG1_Layer2) 64~384(MPEG2_AAC/ MPEG4_AAC)

Audio Source	SDI1 SDI2 SDI3 SDI4 Analog	Volume (dB)	-20~20
AAC Format	ADTS, LATM		

Service Parameter	Range	Service Parameter	Range
Program Name	String between 1~31	Audio PID	32~8190
Provider Name	String between 0~31	PCR PID	32~8190

3.4.5.3 IP Output

This feature is specifically for encoding single program and outputting directly to IP. It will not occupy multicast bandwidth of the baseboard.



If you want to use IP output channel on the encoder module and the baseboard IP module at same time, you should avoid the multicast IP addresses conflicts. If there are two same IP addresses enabled meantime, all the multicast videos will be affected.

- **Destination IP Address and Destination Port:** for multicast IP addresses or unicast IP addresses and ports.
- **Enable Destination MAC:** Generally, you do not need to enable this option. This is reserved for exceptional cases when the unicast stream cannot be received by with the unicast IP addresses. You can enable destination MAC and streaming out by setting Destination MAC.

The second eth is reserved to output IP streams in an another different VLAN. Enabling the second eth and set **IP Address, Subnet Mask, Default Gateway** in the same segment of the Unicast IP (the another different VLAN), you can output the Unicast stream to the another VLAN.

To use **Multiplexing mode on service level**:

1. Click on  (pencil) icon. There will always be a BaseBoard selection for the IP output and other Output options depending on the module inserted.
2. Select the correct Output and Channel you want to output the service to.
3. Check Multiplex on the channel you want to output. You can output multiple services to one channel or output one service to multiple channels.

3.4.6 OHE6-CVBS-00/R01/R01A

OHE6-CVBS-00/R01/R01A is a 6/8/16-channel CVBS encoder with 2/2/4 DB15 connectors (for 3/4/4-channel respectively). It supports H.264/MPEG-2 SD encoding and MPEG1-L2, AAC (optional) and AC3 (optional) audio. One difference of the two modules is, OHE6-CVBS-R01 has insertion features while OHE6-CVBS-00 doesn't have.



OHE6-CVBS-00/R01(6/8 CH)



OHE6-CVBS-R01A (16 CH)

Like all other modules. OHE6-CVBS Status shows the bitrate of each channel and you can check the TS Analysis and Service List here. See picture below.

OHE-CVBS-00										
							Status	Basic Setting	Output	System
Program	Video Resolution	Video Bitrate(Mbps)	Audio Bitrate(Mbps)	Total Bitrate(Mbps)	Effective Bitrate(Mbps)	TS Analysis	Program Name			
1	No_Video	0.000	0.000	0.000	0.000		Program-1			
2	No_Video	0.000	0.000	0.000	0.000		Program-2			
3	No_Video	0.000	0.000	0.000	0.000		Program-3			
4	No_Video	0.000	0.000	0.000	0.000		Program-4			
5	No_Video	0.000	0.000	0.000	0.000		Program-5			
6	No_Video	0.000	0.000	0.000	0.000		Program-6			

OHE-CVBS-R01					
Status Basic Setting Insertion Output System					
Program	Video Resolution	Total Bitrate(Mbps)	Effective Bitrate(Mbps)	TS Analysis	Program Name
1	No_Video	0.000	0.000	👁	Program-01 📌
2	No_Video	0.000	0.000	👁	Program-02 📌
3	No_Video	0.000	0.000	👁	Program-03 📌
4	No_Video	0.000	0.000	👁	Program-04 📌
5	No_Video	0.000	0.000	👁	Program-05 📌
6	No_Video	0.000	0.000	👁	Program-06 📌
7	No_Video	0.000	0.000	👁	Program-07 📌
8	No_Video	0.000	0.000	👁	Program-08 📌

3.4.6.1 Module Basic Settings

Program	Video Encoding Format	Video Bitrate(Kbps)
1	H.264	4000
2	H.264	4000
3	H.264	4000
4	H.264	4000
5	H.264	4000
6	H.264	4000
7	H.264	4000
8	H.264	4000

Click **Advanced Setting** to see all parameters you can modify and check specific parameters you want to set and see. Click the **Apply** button on the right side to make the change take effect.

Click **Advanced Setting** in the line to set encoding parameters.

Video Parameter	Range	Video Parameter	Range
Video Input Format	NTSC, PAL	Brightness	0~100
Video Encoding Format	H264	Contrast	0~100
Video Bitrate (Kbps)	600~6000	Saturation	0~100
GOP Size	1~60	Chrominance	0~100

Profile	HIGH MAIN		
----------------	--------------	--	--

Audio Parameter	Range	Audio Parameter	Range
Audio Encoding Format	MPEG1_Layer2	Audio Bitrate (Kbps)	32~192
Audio Sampling Rate (KHz)	48	Volume (dB)	-20~20
Delay (ms)	-2000~2000		

Service Parameter	Range	Service Parameter	Range
Program Name	String between 1~31	Audio PID	32~8190
Provider Name	String between 0~31	PCR PID	32~8190
Video PID	32~8190	PMT PID	32~8190

OHE6-CVBS-R01/R01A>Settings

OHE6-CVBS-R01 module has 8 channels with 2 DB15 connectors and OHE6-CVBS-R01A module has 16 channels with 4 DB15 connectors. Their configuration is almost the same as OHE6-CVBS-00, except a few differences on parameter setting range.

The screenshot shows the 'Advanced Setting' menu with the following sections and options:

- Video Parameter:**
 - Video Encoding Format
 - Video Bitrate
 - Video Input Format
 - GOP Size
 - Profile
 - Brightness
 - Contrast
 - Saturation
 - Chrominance
- Audio Parameter:**
 - Audio Encoding Format
 - Delay
 - Audio Bitrate
 - Audio Sampling Rate
 - Volume
- Service Parameter:**
 - Program Name
 - Video PID
 - Audio PID
 - PCR PID
 - PMT PID
 - Provider Name
- Shelter Parameter:**
 - X
 - Y
 - Width
 - Height
 - Color
 - Shelter

Video Parameter	Range	Video Parameter	Range
Video Input Format	NTSC, PAL	Brightness	0~100
Video Encoding Format	H264	Contrast	0~100
Video Bitrate (Kbps)	600~6000	Saturation	0~100
GOP Size	1~60	Chrominance	0~100
Profile	HIGH MAIN		

Audio Parameter	Range	Audio Parameter	Range
Audio Encoding Format	MPEG1_Layer2	Audio Bitrate (Kbps)	32~192
Audio Sampling Rate (KHz)	48	Volume (dB)	-20~20

Delay (ms)	-2000~2000		
-------------------	------------	--	--

Service Parameter	Range	Service Parameter	Range
Program Name	String between 1~31	Audio PID	32~8190
Provider Name	String between 0~31	PCR PID	32~8190
Video PID	32~8190	PMT PID	32~8190

Shelter Parameters	Range	Shelter Parameters	Range
Shelter	Enable/Disable	X	0~800 (Dual)
Y	0~600 (Dual)	Width	10~800 (Dual)
Height	10~800 (Dual)	Color	White/Black/Blue/Green/Red

3.4.6.2 Module Output

Direct IP output is specifically for encoding single program and outputting directly to IP. It will not occupy multicast bandwidth of the baseboard.



If you want to use IP output channel on the encoder module and the baseboard IP module at same time, you should avoid the multicast IP addresses conflicts. If there are two same IP addresses enabled meantime, all the multicast videos will be affected.

- **Destination IP Address** and **Destination Port**: for multicast IP addresses or unicast IP addresses and ports.
- **Enable Destination MAC**: Generally, you do not need to enable this option. This is reserved for exceptional cases when the unicast stream cannot be received by with the unicast IP addresses. You can enable destination MAC and streaming out by setting Destination MAC.

The second eth is reserved to output IP streams in another different VLAN. Enabling the second eth and set **IP Address**, **Subnet Mask**, **Default Gateway** in the same segment of the Unicast IP (the another different VLAN), you can output the Unicast stream to the another VLAN.

Direct IP Output		Multiplexing	RTMP Output	
#	Service Name	Destination	Destination Setting	
1	[1] Program-01			
2	[1] Program-02			
3	[1] Program-03			
4	[1] Program-04			

To use **Multiplexing mode on service level**:

1. Click on (pencil) icon. There will always be a BaseBoard selection for the IP output and other Output options depending on the module inserted.
2. Select the correct Output and Channel you want to output the service to.
3. Check Multiplex on the channel you want to output. You can output multiple services to one channel or output one service to multiple channels.

3.4.6.3 System Operation

System tab allows you to perform the following tasks:

- Import / export license
- Log manages
- Reboot
- Factory Default

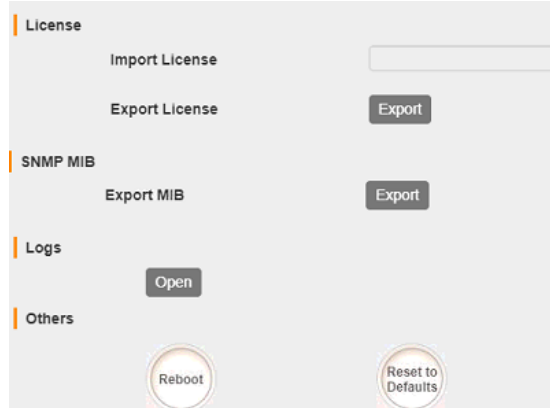

To open the log management menu, click on the **Open** button. The newly opened menu allows you to enable / disable logging.

After login is enabled, additional control buttons will be displayed:

- clean log, clean screen, export logs, filter dialog box

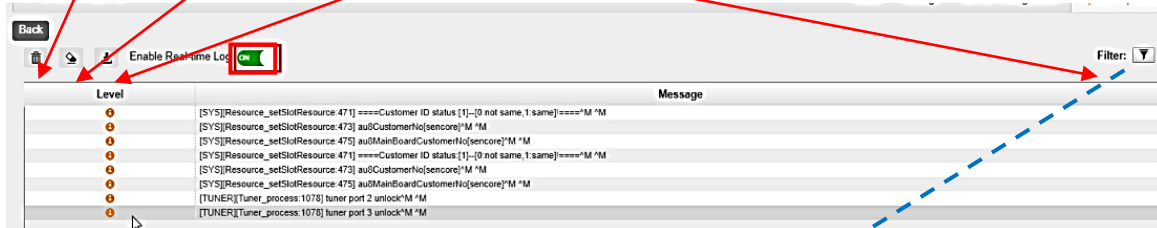

Filter

Level	
Level	Operation
Error	<input checked="" type="checkbox"/>
Warning	<input checked="" type="checkbox"/>
Information	<input checked="" type="checkbox"/>
Debug	<input type="checkbox"/>

Module List	
Module Name	Operation
SYS	<input checked="" type="checkbox"/>
PARAMS	<input checked="" type="checkbox"/>
UPGRADE	<input checked="" type="checkbox"/>
TSPROCESS	<input checked="" type="checkbox"/>
SIPROCESS	<input checked="" type="checkbox"/>
LICENSE	<input checked="" type="checkbox"/>

3.5 Modulation Modules

3.5.1 OHM6-QAMA-00/R00

OHM6-QAM-00 / R00 / R01 / R01A module supports modulating 16 non-adjacent channels with 1 RF port and 1 RJ45 network port that is reserved for future use. QAM A and B share the same Hardware but Different Software. If you need to change the Module from A to B, please contact your local support for assistance.



3.5.1.1 Module Status

Status of QAMA6-00 shows the Total Bitrate of a TS and the Effective bitrate, with which you can monitor if the output programs will overflow in a certain TS. Since the Modulator produces a lot of heat, the Module is also designed to automatically powered off when the temperature is higher than 74 degrees Celsius (165.2 degrees Fahrenheit). The status page for all Output modules of OmniHub 6/6D are mostly the same with each other and with all other modules. You will notice there is not much difference in every link on the status page. See OHR6-DVBC-00 on page 30 for reference.

Channel	Effective Bitrate(Mbps)	Total Bitrate(Mbps)	Bitrate	TS Analysis	Service List
1.1	0.000	0.000	Normal	👁	☰
1.2	0.000	0.000	Normal	👁	☰
1.3	0.000	0.000	Normal	👁	☰
1.4	0.000	0.000	Normal	👁	☰
1.5	0.000	0.000	Normal	👁	☰
1.6	0.000	0.000	Normal	👁	☰
1.7	0.000	0.000	Normal	👁	☰
1.8	0.000	0.000	Normal	👁	☰
1.9	0.000	0.000	Normal	👁	☰
1.10	0.000	0.000	Normal	👁	☰
1.11	0.000	0.000	Normal	👁	☰
1.12	0.000	0.000	Normal	👁	☰
1.13	0.000	0.000	Normal	👁	☰
1.14	0.000	0.000	Normal	👁	☰
1.15	0.000	0.000	Normal	👁	☰

3.5.1.2 Module Basic Settings

This page is where you can modify or set the frequency for the RF modulation. OHM6-QAMA-R00 has 16 non-adjacent channels while OHM6-QAMA-R01 has 4 adjacent channels both at single port.

RF Level: -56 (dBmV ● dBuV ○) PSI/SI Interval(ms): 100

Channel	Enable	Frequency(KHz)	Bandwidth(MHz)	Constellation	SymbolRate(KBaud)
1.1	<input type="checkbox"/>	200000	8	QAM64	6875
1.2	<input type="checkbox"/>	208000	8	QAM64	6875
1.3	<input type="checkbox"/>	216000	8	QAM64	6875
1.4	<input type="checkbox"/>	224000	8	QAM64	6875



Click the Apply button on the right side for the changes to take effect.

Name	Range	Name	Range
QAM Mode	ANNEX A/ ANNEX B	RF level	0~63
Bandwidth	6M, 7M, 8M	Frequency (KHz)	48000~858000
Symbol Rate (KBaud)	4400~6956	Constellation	QAM16/32/64/128 /256
PSI/SI Interval (ms)	50~10000		

3.5.1.3 Module Output

QAM Output will be different from the Receiver and Encoder module. Since the QAM module is an output module like IP output, all service configured in receiver, encoder and IP input will be seen here.

Every Channel in QAM output has Original Network ID and TS ID. It is important to identify the TS ID properly. Labeling the TS will help you to monitor your output services. It is also important for creating NIT for LCN and Cable Descriptors. When you click on the Service Settings, this is the screen you will see first.

NO.	Service ID	Service Name	Service Provider
1	1	Program0	Program0

On the Left side, you will see the list of TS where there are output services. If the TS or Channels are enabled but no Service Output, it will not be listed here.

You will also see the Original Network ID and TS ID where you can modify the details and below will be the list of the service in the Selected TS. Initially, TS 1 is selected when you first select the Service Configuration tab.

Clicking on the Program name under the TS will show the Programs Basic Parameter where you can modify each detail.

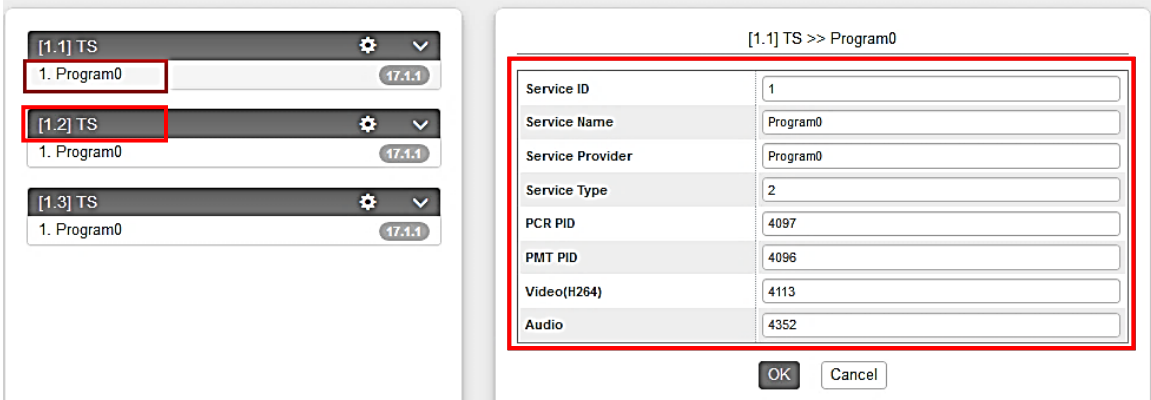

Clicking on the icon  will show you the NIT setting where you can create and add NIT Network and NIT Stream.

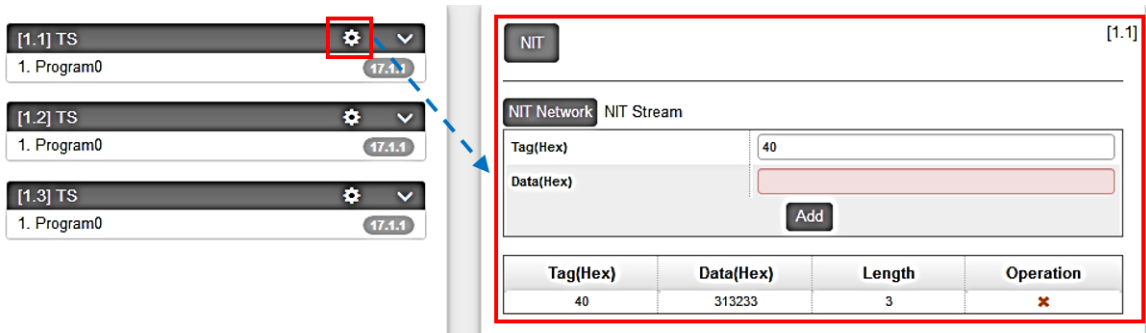

For NIT Stream, you can create Cable Descriptor and Logical Channel Number LCN. You need to Add and Input first the correct Original Network ID and TS ID. Once it is done, click on the plus icon “+” under Operation and select the Descriptor you want to add.

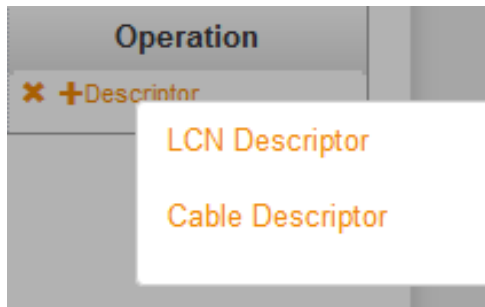

For Cable Descriptor, this is used for the STB to scan all configured frequencies on the network given that the STB triggering Frequency is set where the NIT frequency is created. e.g., If the NIT is created in TS ID 10 with frequency 539MHz and 5057Kbaud Symbol rate, the STB “Autosearch Setup” or setting should has the same parameters for Frequency and Symbol rate.

One important information is to know in what frequency and TS you want to create the Cable Descriptor. Once you know the frequency, you need to create the TSID currently used. If you have 4 frequency outputs on the Network, you need to create 4 TSID as shown below. Just input the correct Frequency on each TS and add. Repeat the procedure until all the Frequencies are added.

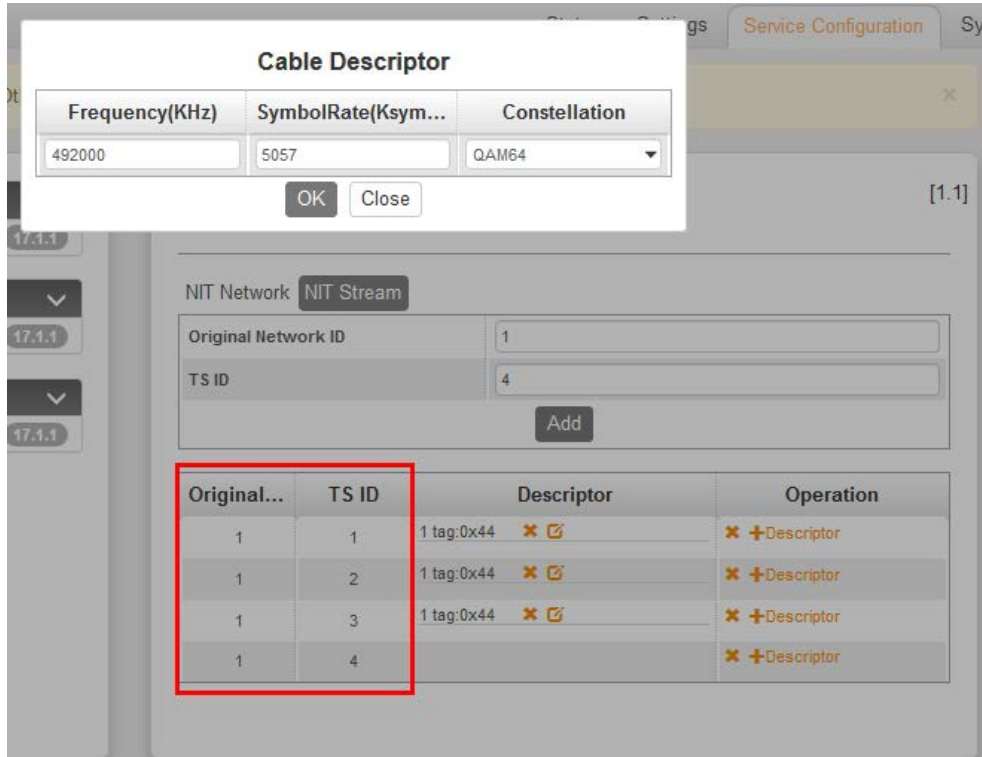

LCN or Logical Channel Number are created in the same way with Cable Descriptor. On 1 frequency, you will add NIT Stream and create multiple TSID. Here you will add the LCN on each TSID.

To add the LCN:

1. Click LCN Descriptor and see a small window appear.
2. Click Select Service on the upper right corner and select the program name. Make sure that the name is on the correct TS where you are adding the LCN to.
3. Input the Channel number you want that program to appear. Note that the STB sorting settings should be also in LCN. STB has other sorting settings like By Name, By Frequency, By Service ID, By LCN, etc.

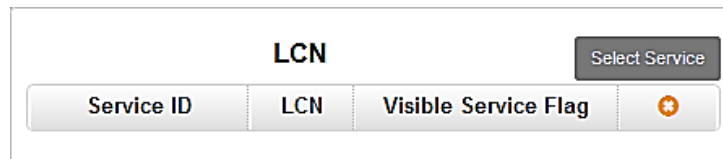

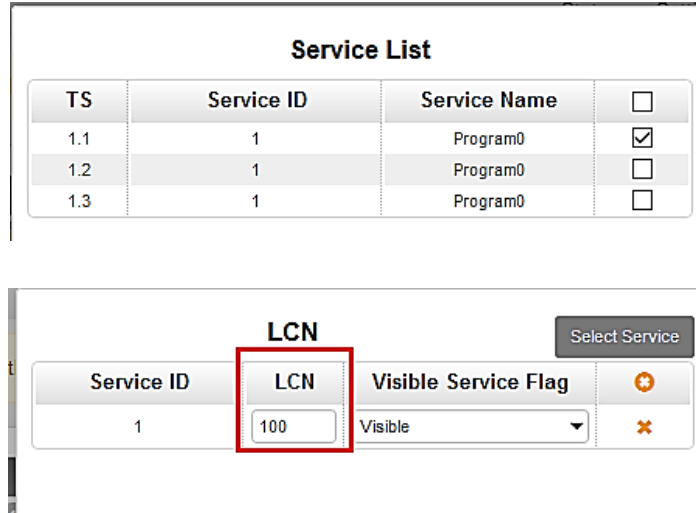

3.5.2 OHM6-QAMA-R01/R01A

OHM6-QAMA-R01 and OHM6-QAMA-R01A are 4 channel and 8 channel modulators. They share the same hardware but have different software. For the Status, Settings, Service Configuration and System Operation, please refer to previous module OHM6-QAMA-00/R00 at page 74 to 77.

3.5.3 OHM6-QAMB-00/R00

OHM6-QAMB-00 / R00 module supports up to 16 non-adjacent frequencies modulating with 1 RF female connector for output.



3.5.3.1 Module Status

Please see OHR6-DVBC-00 on page 30 for reference. See also the image for QAMB Status.

Channel	Total Bit Rate(Mbps)	Effective Bit Rate(Mbps)	Bit Rate	TS Analysis	Service List
1.1	38.810	0.073	Normal		
1.2	0.000	0.000	Normal		
1.3	0.000	0.000	Normal		
1.4	0.000	0.000	Normal		
1.5	0.000	0.000	Normal		
1.6	0.000	0.000	Normal		
1.7	0.000	0.000	Normal		
1.8	0.000	0.000	Normal		

3.5.3.2 Module Basic Settings

This page allows you to type in the output parameter for the QAM required by the network.

RF Level (dBmV): 42 PSI/SI Interval(ms): 100 Channel Standard: STD

Channel	Enable	Channel No.	Bandwidth(MHz)	Constellation	SymbolRate(KBaud)
1.1	<input checked="" type="checkbox"/>	CH2-57MHz	6	QAM256	5361
1.2	<input type="checkbox"/>	CH3-63MHz	6	QAM256	5361
1.3	<input type="checkbox"/>	CH4-69MHz	6	QAM256	5361
1.4	<input type="checkbox"/>	CH5-79MHz	6	QAM256	5361
1.5	<input type="checkbox"/>	CH6-85MHz	6	QAM256	5361

Click the **Apply** button on the right side to make the change take effect.

Name	Range	Name	Range
Bandwidth (MHz)	6	Channel Standard	US cable/STD/IRC/HRC
Symbol Rate (KBaud)	5056.941 (QAM 64) 5360.537 (QAM 256)	RF level	15~48 (dBmV)
PSI/SI Interval (ms)	50~10000	Constellation	QAM 64/256
Channel No.	Up to Channel Standard		

3.5.3.3 Module Output

Service Configuration for QAMB are very simple compared to QAMA. You can edit the Original network ID and TSID to the correct label. You can also edit the Service parameter like Service ID, Name, Provider, PID, etc.,

System operation of OHM6-QAMB are same with other modules. See page 74 to 77 for reference.

3.5.4 OHM6-QAMB-R01/R01A

OHM6-QAMB-R01 is a 4 channel QAM B Modulator module while OHM6-QAMB-R01A is an 8 channel QAM B modulator. The Status, Setting Service Configuration and System Operation for these two modules are same with the OHM6-QAM-00/R00. See page 74 to 77 for reference.

3.5.5 OHM6-8VSB-R01/R01A

OHM6-8VSB-R01A module supports up to 4/8 adjacent frequencies modulating with 1 RF connector for output.

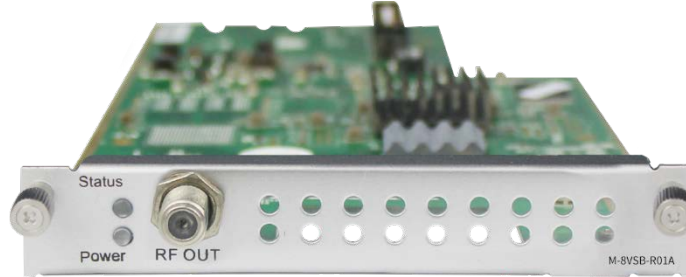

Please see QAM configuration on page 74 for reference

3.5.5.1 Module Basic Settings

RF Level: 30 (dBmV dBuV) PSI/SI Interval(ms): 100 Channel Standard: OFF-AIR

Channel	Enable	Frequency
1.1	<input checked="" type="checkbox"/>	CH2-57MHz
1.2	<input checked="" type="checkbox"/>	CH2-57MHz
1.3	<input checked="" type="checkbox"/>	CH2-57MHz
1.4	<input checked="" type="checkbox"/>	CH2-57MHz

Click the **Apply** button on the right side to make the change take effect.

Name	Range	Name	Range
RF level (dBmV)	28~48	PSI/SI Interval (ms)	50~10000
Channel Standard	OFF-AIR, STD, IRC, HRC	Channel - Frequency	CH2 - 57MHz ~ CH69 – 803MHz

3.5.5.2 Module Output

TS setting: Please refer to IP output service configuration on page 26 for reference. Select the modulation mode: Analog, SCTE_Mode 1, SCTE_Mode 2, or ATSC (8VSB).

[1.1] TS

Original Network ID	0		
TS ID	0		
Modulation Mode	ATSC (8 VSB) Analog SCTE_Mode 1 SCTE_Mode 2 ATSC (8 VSB)		
NO.	Service ID	Se	Encoder
1	1	Program-02	Encoder

3.5.6 OHM6-OFDM-R01/R01A

OHM6-OFDM-R01 / R01A module supports up to 4/8 adjacent frequencies modulating with 1 RF female connector for output. The status for the OHM6-OFDM is like in OHM6-QAMA and another modulator module. It will show Lock Status of each channel when the signal is stable.



Channel	Effective Bitrate(Mbps)	Total Bitrate(Mbps)	Bitrate	TS Analysis	Service List
1.1	0.001	23.751	Normal		
1.2	0.000	0.000	Normal		
1.3	0.000	0.000	Normal		
1.4	0.000	0.000	Normal		

3.5.6.1 Module Basic Settings

For the Settings of OHM6-OFDM-R01

Channel	Enable	Frequency(KHz)	Bandwidth(MHz)	FFT Mode	GI Mode	QAM Mode	Convolutional Coding
1.1	<input checked="" type="checkbox"/>	755143	6	2K	1/32	64QAM	7/8
1.2	<input checked="" type="checkbox"/>	761143	6	2K	1/32	64QAM	7/8
1.3	<input checked="" type="checkbox"/>	767143	6	2K	1/32	64QAM	7/8
1.4	<input checked="" type="checkbox"/>	773143	6	2K	1/32	64QAM	7/8

Module Settings is where you can input the source parameters. Once it's done, click on Apply for the changes to take effect and check on the Status of the channel that the signal is Locked.

Name	Range	Name	Range
Bandwidth	6M, 7M, 8M	RF level	0~31.5 (dBmV) 60~91.5 (dBuV)
Frequency (KHz)	48000~862000		

3.5.6.2 Module Output

Configuration of the OFDM module is like the configuration of OHM6-QAMA-00/R00. You can also change the Original Network ID, TSID, Service Name, PID and create LCN Descriptor and Cable Descriptor. For more details, please check OHM6-QAMA-00 on page 74 for reference.

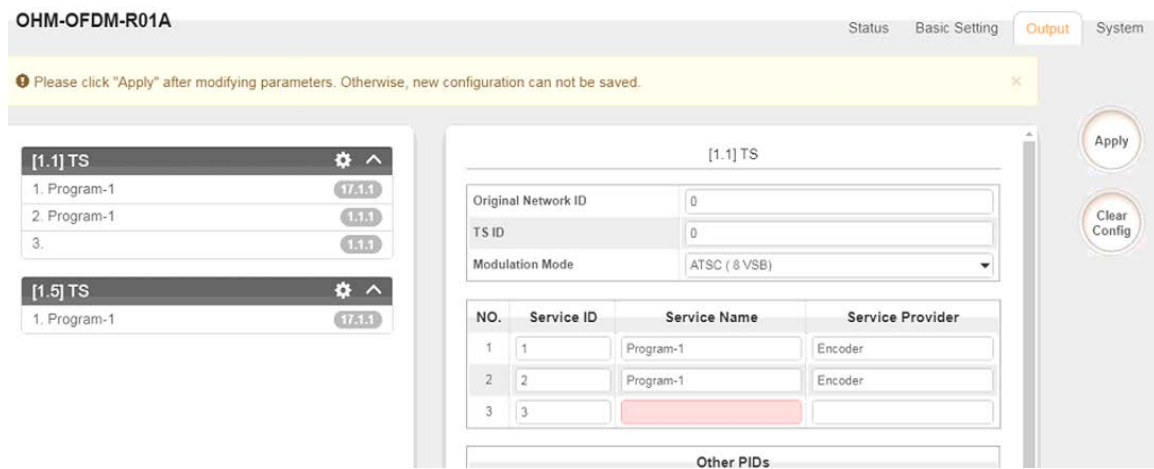

3.5.7 OHM6-ISDBT-R01/R01A

OHM6-ISDBT-R01/R01A module supports up to 4/8 adjacent frequencies modulating with 1 RF female connector for output.

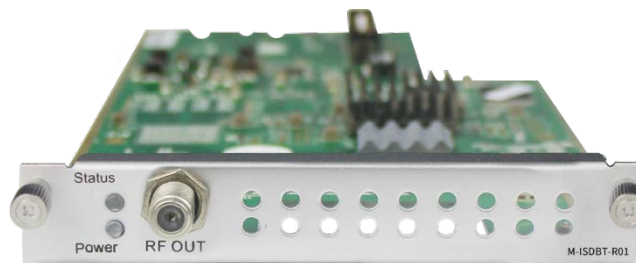

3.5.7.1 Module Basic Settings

After inputting the parameters in the Modules Settings, always click the **Apply** button on the right side to make the change take effect. Make sure the Signal is locked on the Module Status page.

RF Level: 40 (dBmV ● dBuV ○)

Channel	Enable	Frequency(KHz)	Bandwidth(MHz)	FFT Mode	GI Mode	QAM Mode	Convolutional ...	Segment Mode
1.1	<input checked="" type="checkbox"/>	474000	6	2K	1/4	64QAM	7/8	Full Seq
1.2	<input type="checkbox"/>	480000	6	2K	1/4	64QAM	7/8	Full Seq
1.3	<input type="checkbox"/>	486000	6	2K	1/4	64QAM	7/8	Full Seq
1.4	<input type="checkbox"/>	492000	6	2K	1/4	64QAM	7/8	Full Seq

Name	Range	Name	Range
Bandwidth (MHZ)	6M	RF level	90~110
Frequency (KHz)	48000~862000	FFT Mode	2K
GI Mode	1/4, 1/8, 1/16, 1/32	RF Level Gain (dB)	45~55
QAM Mode	QPSK 16QAM 64QAM	Convolutional Coding	1/2, 2/3, 3/4, 5/6, 7/8

3.5.7.2 Module Output

RF Level: 40 (dBmV ● dBuV ○)

Channel	Enable	Frequency(KHz)	Bandwidth(MHz)	FFT Mode	GI Mode	QAM Mode	Convolutional ...	Segment Mode
1.1	<input checked="" type="checkbox"/>	474000	6	2K	1/4	64QAM	7/8	Full Seq
1.2	<input type="checkbox"/>	480000	6	2K	1/4	64QAM	7/8	Full Seq
1.3	<input type="checkbox"/>	486000	6	2K	1/4	64QAM	7/8	Full Seq
1.4	<input type="checkbox"/>	492000	6	2K	1/4	64QAM	7/8	Full Seq

- TS setting: Please refer to IP output service configuration on page 30.
- LCN setting: You need to add NIT stream of all frequencies in the base TS (frequency). It is used for your STB to automatically search and identify all the TS (frequencies) LCN information.
- Check or reset each TS (frequency) Original Network ID and TS ID, which should be different in each TS.
- Fill the Original Network ID and TS ID of each TS (frequency) in the field of the base TS (frequency) and then click Add to create a NIT stream of this TS (frequency).
- Click the “+” icon of Descriptor and add the TS Information Descriptor in. Then fill in the correct parameters and click OK. (This operation should be set on Modulator module only)

TS Information Descriptor

Remote Key ID [0, 255]

TS Name

Trans Info Type [0, 255]

OK Close

- Click the “+” icon of Descriptor and add the LCN Descriptor. Then check all the programs which are contained in this frequency. Then set program LCN.

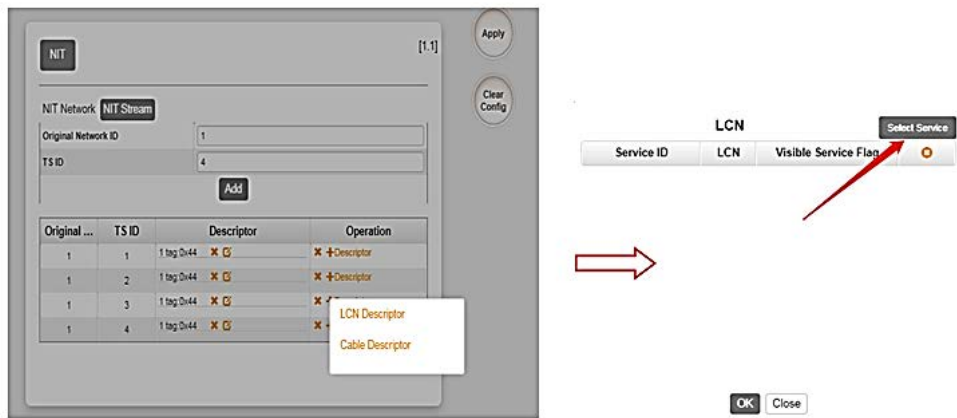

- Do same operations to add next TS (frequency) until NIT streams of all the frequencies have been included. Lastly click Apply button to let all configuration take effect. Then searching programs in your STB, you will get all programs in order of LCN which you set.

3.6 Function Modules

3.6.1 OHP6-EAS

The OHP6-EAS-00 module provides the ability to interrupt Encoder playback and switch to an external transport stream. This feature is for the US market and requires the OmniHub chassis to be set for ATSC standard. A common application of Emergency Alert Systems is for Broadcast and Audio Muting.

The trigger switched video content on the Encoders can be sensed using a DC contact closure or the SCTE-18 EAS standard over ASI/IP when the EAS is “Paved” or actively replacing the encoder outputs.



3.6.1.1 Module Settings

Below is an example of the EAS module configuration settings with some additional descriptions. Click the **Apply** button on the right side of the EAS settings page to make the change take effect.

EAS Source Setting	
EAS Signal Input:	Digital(IP)
EAS Program Input:	AV
Trigger Mode:	Normally Open

EAS Signal Input is where you select how the module senses the trigger:

- Digital – Trigger is provided via IP (SCTE-18 Broadcast Standard)
- Analog – Trigger is provided as DC voltage to the EAS Control connector

EAS Program Input. Here you can select where the content originates from.

- AV – Content is provided as RCA/Analog AV inputs to EAS built in the encoder
- ASI – Content is provided as ASI with MPEG Transport Stream

Command Input Setting	
PID:	1
IP Address:	192.1.1.100
IP Port :	5050

Command Input Settings. You specify the incoming PID, IP, and Port of the SCTE-18 triggers over the Ethernet cable. The **IP EAS IN** RJ45 Ethernet port on the module is where this information must be received.

Encoder Setting	
Video Type:	Mpeg-2
Audio Type:	Mpeg4-AAC
Video Bitrate (Kbps):	5000
Audio Bitrate (Kbps):	320
Volume:	10

Encoder Settings. This section is for the RCA / Analog-AV inputs. When the takeover content is provided in this fashion it must be encoded to MPEG “.TS” Transport Stream data. The Video, Audio, and Bitrate settings are used to configure the format.

IP Output Setting ▼

Note: Don't take up the UDP multicast address, avoid the IP conflict. If you want to modify them, you need to modify other subboards synchronously.

Editable:	<input type="text" value="Enable"/>
IP Address:	<input type="text" value="227.10.50.60"/>
Command Port:	<input type="text" value="1235"/>
Data Port:	<input type="text" value="1234"/>

IP Output Settings

You can configure the command sent from the EAS module to the encoders. The settings applied here must match in the EAS tab of each Encoder Module.

Table of all parameters in the EAS module:

Name	Range	Name	Range
Command Input Setting			
EAS Signal Input	Digital (IP) Analogue (Dry Contact)	EAS Program Input	ASI AV
Trigger Mode	Normally Open Normally Closed		
Encoder Setting			
Video Type	H.264, MPEG-2	Audio Type	AC3, Mpeg-1 Layer 2 Mpeg2-AAC, Mpeg4-AAC
Video Bit rate (Kbps)	1500~20000	Audio Bitrate (Kbps)	128, 192, 256, 384
Volume	-10~10		

Example of the EAS module Status Page:

EAS Status	
EAS Status:	Digital Locked
AV Input	
Video Resolution:	720x576_50i
Encoder Status	
Total Bit Rate:	8.190 Mbps
Effective Bit Rate:	7.709 Mbps
Video Resolution:	720x576_50i
ASI Input	
Signal Lock:	Locked
Total Bit Rate:	8.578 Mbps
Effective Bit Rate:	8.441 Mbps
Program Scan Status:	Normal
IP Output	
Total Bit Rate:	8.655 Mbps
Video Bit Rate:	6.172 Mbps
Audio Bit Rate:	0.251 Mbps
Effective Bit Rate:	7.726 Mbps
Version Info	
Firmware Version:	V0.2.0
Software Version:	V0.0.32
Hardware Version:	V0.0.0

3.6.2 OHP6-CAM-00

OHP6-CAM-00 is used to decrypt and encrypt services. It has 2 independent CI card slots that are compatible with mainstream CAM cards but support only Xcrypt CAM CAS for encryption and supports mainstream CAS decryption.



3.6.2.1 Module Status

Click the name of OHP6-CAM-00 in the module list to view its Status page. This page will show you the status of each channel and the bitrate of each service. See OHR6-DVBC-00 on page 30 to 35 for reference

13: CP-CAM-00				
Channel	Total Bitrate(Mbps)	Effective Bitrate(Mbps)	TS Analysis	Service List
1.1	5.443	5.443	👁	☰
1.2	5.443	5.443	👁	☰

Note that this module has scrambling and descrambling functions. To choose which function you want to use, go to System Operation and select the CAM mode.

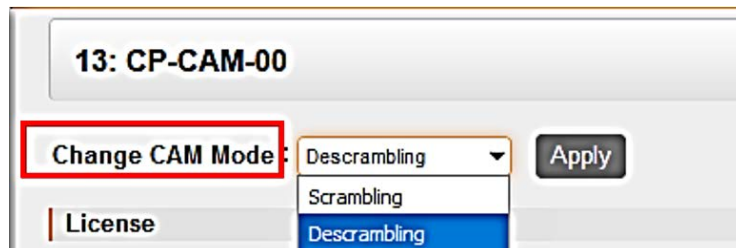

3.6.2.2 CI

You can output the received encrypted services in DVBS2, DVBC, ISDT, etc. to OHP6-CAM-00 to decrypt the service and rebroadcast it to QAM, OFDM, IP, etc. The CI page will show you the list of the successfully-decrypted services in the channel.

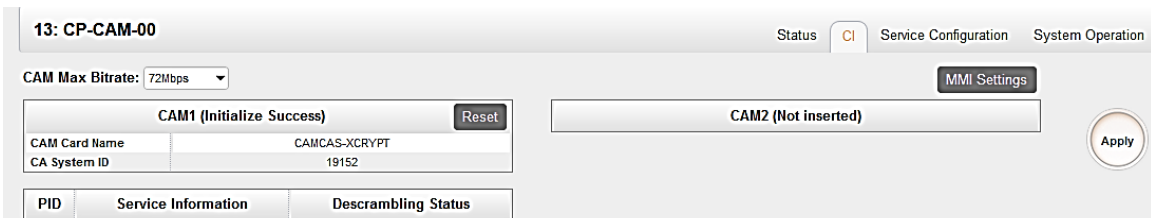
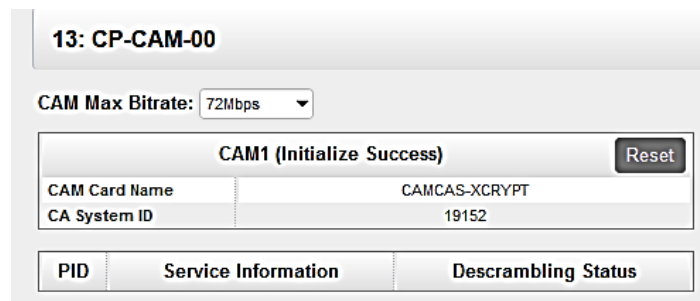

3.6.2.3 Service Configuration

For the Service Configuration, you can select Descrambling or No Descrambling for a service before output. To configure the service to output, please refer to service configuration procedures of other modules.

*You need to click **Apply** button after you configure service to Descrambling, otherwise the descrambling configuration will not be saved.

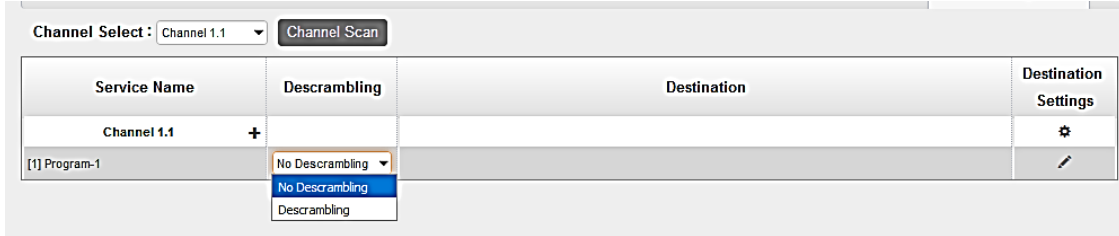

3.6.3 OHP6-EIT-00

OHP6-EIT-00 is a function enabled by default on the modulator and disabled in all IP output channels of the baseboard. This is only used when a certain service has wrong EIT information or the total output TS with EIT enabled exceeds the maximum limit of the 16 for each EIT module or an IP output channel that requires an EIT output.

3.6.3.1 Module Status

Status display the EIT enabled module and the list of service that enabled EIT.

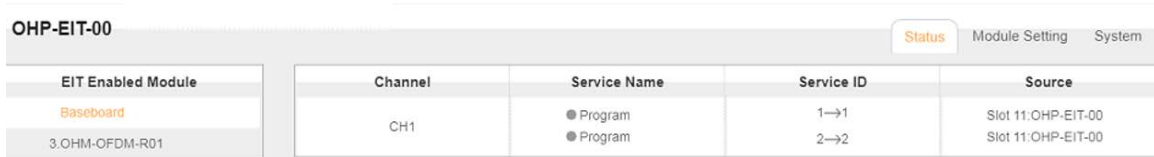

3.6.3.2 Module Setting

You just need to click the checkbox to enable or disable EIT function of relative TS streams or services.

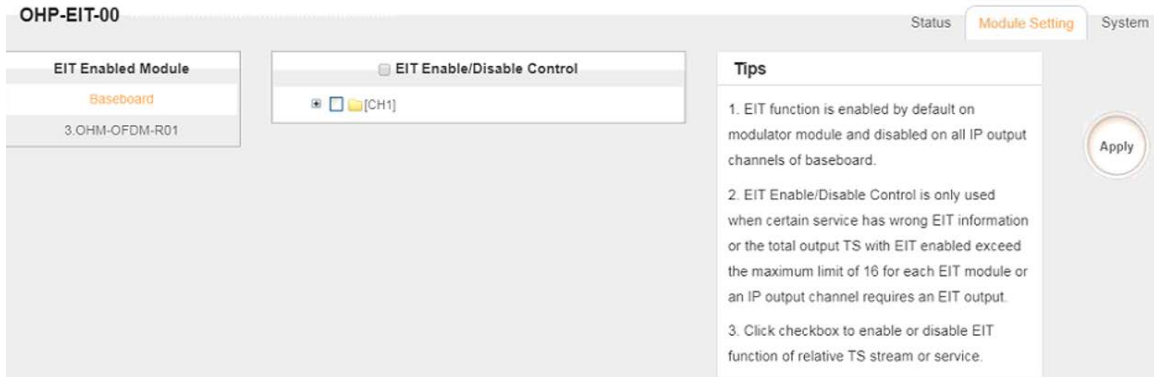

3.6.3.3 Module System

System is for you to upgrade license of the board when needed. Here you can also check logs, reboot and reset the unit to factory default.

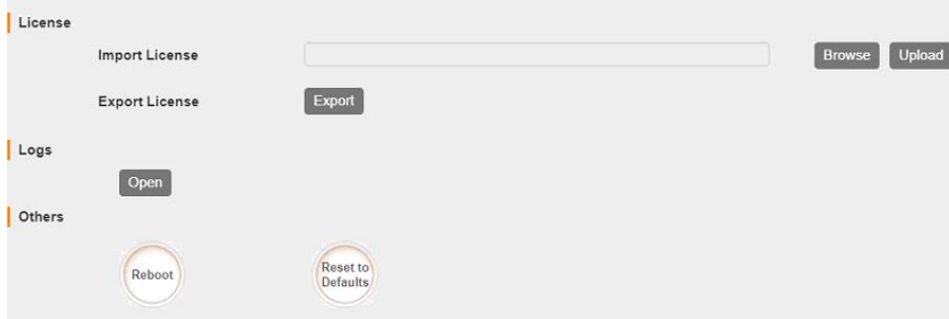

Section 4 Appendices



SECTION 4 APPENDICES	92
APPENDIX A - ACRONYMS AND GLOSSARY	93
APPENDIX B - AMONROE ONENetSE CONFIGURATION AND TESTING	94
APPENDIX C - SPECIFICATION	97
APPENDIX D - WARRANTY	111
APPENDIX E - SUPPORT AND CONTACT INFORMATION	111
1 <i>Returning for Service or Calibration</i>	111
2 <i>RMA Number</i>	111
3 <i>Shipping the Product</i>	111

APPENDIX A - Acronyms and Glossary

AAC	Advanced Audio Coding
AC-3	Also known as Dolby Digital
AES	Audio Engineering Society
ATSC	Advanced Television Systems Committee
AV	Audio Video
BAT	Bouquet Association Table
BER	Bit Error Ratio
Bit Rate	The rate at which the compressed bit stream is delivered
BNC	British Naval Connector
CAM	Conditional Access Module
CAT	Conditional Access Table
CBR	Constant Bitrate
CI	Common Interface
CVBS	Composite Video Broadcast Signal
dB	Decibel
DVB	Digital Video Broadcasting
EAS	Emergency Alert System
EIT	Event Information Table
EPG	Electronic Program Guide
FEC	Forward Error Correction
GOP	Group of Pictures
HD	High Definition
HDCP	High-bandwidth Digital Content Protection
HDMI	High Definition Multimedia Interface
Kbps	1000 bit per second
LED	Light Emitting Diode
LNB	Low-Noise Block
Mbps	1,000,000 bits per second
MER	Modulation Error Ratio
MPEG	Refers to standards developed by the ISO/IEC JTC1/SC29 WG11, Moving Picture Experts Group. MPEG may also refer to the Group.
MPEG-2	Refers to ISO/IEC standards 13818-1 (Systems), 13818-2 (Video), 13818-3 (Audio), 13818-4
MPTS	Multi-program Transport Stream
NIT	Network Information Table
OFDM	Orthogonal Frequency-Division Multiplexing
PAT	Program Association Table
PCR	Program Clock Reference
PID	Packet Identifier
PMT	Program Map Table
PSI	Program Specific Information
PSU	Power Supply Unit

QAM	Quadrature Amplitude Modulation
QPSK	Quadrature Phase-Shift Keying
SD	Standard Definition
SDT	Service Description Table
SI	Service Information
SNMP	Simple Network Management Protocol
SNR	Signal Noise Ratio
SPTS	Single Program Transport Stream
TDT	Time and Date Table
TS	Transport Stream
VBR	Variable Bitrate

APPENDIX B - A Monroe OneNetSE Configuration and Testing

For development and testing purposes, the Monroe OneNetSE will be used to supply the SCTE18 messages and the EAS substitutions audio and video. The Monroe box will need to be configured in a very specific way in order to work with the proposed OmniHub 6/6D EAS features.

External Configuration

1. The first step is to connect an Ethernet cable to the unit and supply power. Turn on the unit using the switch on the back. The unit is configured for DHCP on the management port. If a static IP needs to be assigned, this will need to be done according to the Monroe manual.
1. Connect the CVBS video and analog-unbalanced audio to an encoder module. Outputs shown in the picture below will be where the video and audio substitutions will come out.



2. Once the unit boots, the front panel display will show the DHCP IP address of the Monroe box. Use this IP address to access the unit with a web browser.

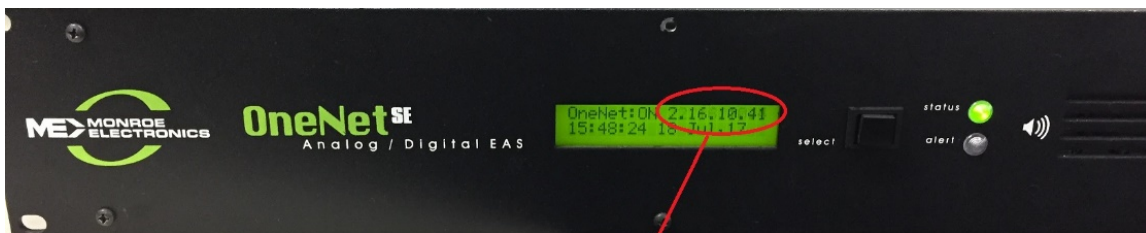

IP Address scrolls across the screen

Webpage Configuration

1. The webpage for the Monroe box requires login. The Monroe box has been configured with this login information (The capital “A” in the username is required):

User: Admin

Password: sencore12

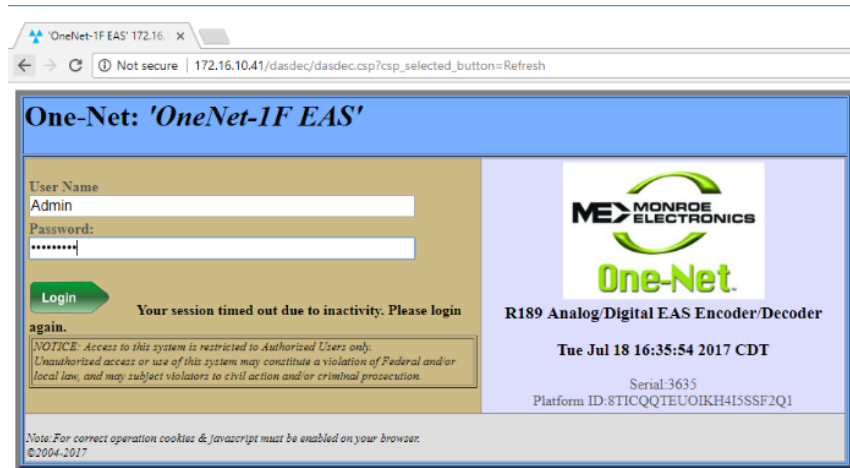

2. Once logged into the unit, browse to the Setup tab and select Net Alerts.
3. Configure the DVS644 (SCTE18) settings in the Monroe exactly like what are shown below. **Enable Alert Forwarding and Encoder Originated Alerts to be sent to DVS644/SCTE18 devices.**

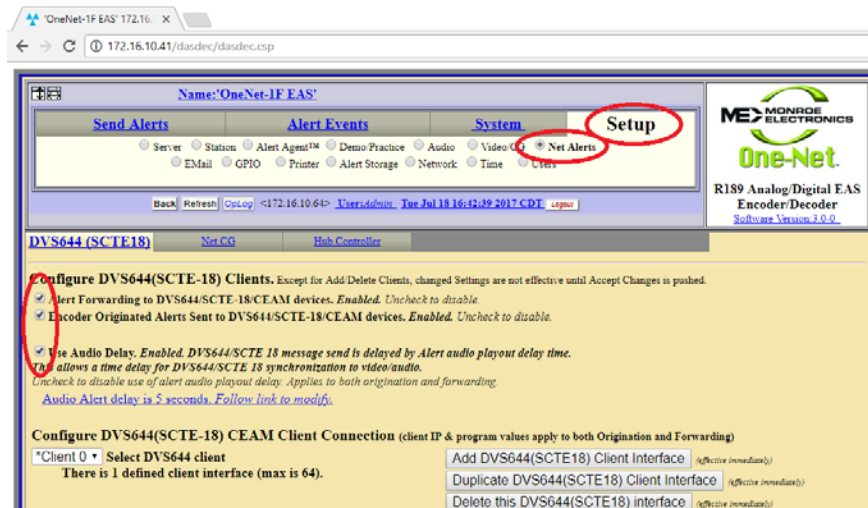

4. A DVS644(SCTE-18) CEAM Client Connection should already be configured. If not, click the **Add DVS644(SCTE18) Client Interface** button.
5. Make sure Client 0 is enabled and then input the unicast **or** multicast address into the “Remote Host Unicast or Multicast IP Address” text box. It is suggested the unicast normally be used, so what should be put in this box is the management

IP address of the OmniHub 6/6D. It is also possible to input a multicast address (224.x.x.x – 239.x.x.x).

Client 0 Client Interface Name

ENABLE Client Interface. *Enabled. Uncheck to disable client.*

172.16.10.64 Remote Host Unicast or Multicast IP Address 0 Details Video OOB ID

5050 Remote Host Port 0 Details Audio OOB ID

0 Multicast TTL (0..200) 0 Details InBand Major Channel

Advanced DSG Delivery. *Disabled.* 0 Details InBand Minor Channel

Using Standard MPEG2 Transport Stream Delivery.

Check to enable Advanced DSG Delivery.

In-Band. *Disabled. Using Out-Of-Band PID=1FFC.*

Check to enable In-Band PID=1FFC.

Send internal EAT control event at EAN,NPT End of Message. *Enabled.NOTE! This may be REQUIRED for ending force tune during EAN and NPT National alerts by some downstream STBs and other SCTE18 receiving devices!.*

Exception Channel List. *Disabled. Check to enable Exception Channels.*

In-Band Details Channel Descriptor (Tag=0x00). *Disabled. Check to enable In-Band Details Channel Descriptor.*

In-Band Exception Channels Descriptor (Tag=0x01). *Disabled. Check to enable In-Band Exception Channels Descriptor.*

Audio File Descriptor (Tag=0x02). *Disabled. Check to enable Audio File Descriptor.*

MPEG Audio Sync Private Descriptor (Tag=0xE1). *Disabled. Check to enable MPEG Audio Sync Private Descriptor.*

NDS Tune Private Descriptor (Tag=0xE8). *Disabled. Check to enable NDS Tune Private Descriptor.*

Generic Private Descriptor. *Disabled. Check to enable Generic Private Descriptor.*

6. Make sure the “Remote Host Port” is configured to be 5050 as this is the default port for SCTE18 messages and it is not planned to have the OmniHub 6/6 listen for SCTE18 messages on any other port.
7. Also make sure the **In-Band** checkbox is disabled. The OmniHub 6/6 will be using the Out-Of-Band PID = 0x1FFC.
8. Another very important configuration is that the **Alert Repeat Control** must be set to “Always repeat alert send” and the **Alert Message Repeat Period** should be set to 6 seconds.

DVS644 (SCTE18) Net.CG Hub Controller

Generic Private Descriptor. *Disabled. Check to enable Generic Private Descriptor.*

Set Alert type priority selection
(NOTE: EAN are always 15)

Low:3 ▾ Advisories

Low:3 ▾ Tests

Low:3 ▾ Watches

Medium:7 ▾ Warnings

High:11 ▾ Emergencies

High:11 ▾ National Test

NPT initial duration 120 secs. *Disabled.*
Will be 0 like EAN.

Immediate Start. *Disabled. Alert Start Time on Receiving Device based on Encoder Clock Time.*
Check to set immediate start time.

Multiple Language Alert Text. *Disabled.*

Send Alert Text at all priority levels ▾ Alert Text Control

Always repeat alert send ▾ Alert Repeat Control

6 Alert Message Repeat Period(6-60 seconds)

Decrement SCTE18 Time remaining with each repeat period
(incrs sequence num). *Enabled. Does not apply to EAN or 0 duration NPT.*

2 Alert Message Transmission Duplication Count (1-20)

0 Additional Start Delay Time (seconds).

Start Delay == (Audio Delay if enabled) + Additional Time
DVS644/SCTE 18 message send delay time = 5 seconds.

0 Duration Extension Time (seconds).

Alert Duration == Audio Duration + Extension Time
(max total is 120 seconds)

All FIPS codes trigger. *Enabled.* All FIPS locations will trigger DVS644/SCTE-18/CEAM device. *Uncheck to choose specific triggering FIPS.*

All EAS codes trigger. *Enabled.* Alerts with any EAS code will trigger DVS644/SCTE18 send. *Uncheck to choose specific triggering EAS Codes.*

9. Click the Accept Changes button and that should be the last of the configuration.

EAS Testing with Monroe Box

1. To force the Monroe box to do a test and send an SCTE18 message, press the **Select** button on the front panel of the unit **TWO TIMES**.

This will cause the unit to:

- a. Display an EAS screen on the CVBS video output
 - b. Send two SCTE18 messages
 - c. Start playing the alert audio
2. The SCTE18 messages will continue to be sent during the playing of the EAS audio message every 6 seconds. When the EAS audio message playing is finished, the SCTE18 messages will no longer be sent.
 3. When the OmniHub 6/6 receives the first SCTE18 message on the management port, it should trigger it to replace all services on the output with an encoded version of the Monroe video and audio outputs. 15 seconds after the last SCTE18 is received, the OmniHub 6/6 should return all services to their original content.

APPENDIX C - Specification

OmniHub 6/6D - Base unit

Includes -	1RU chassis/case, power supply/line cord
Systems -	
Chassis Dimension	445mm x 44mm x 428mm (W x H xD), 1RU
Front Panel	4 Gigabit Ethernet port
Rear Panel	6 Hot Swappable Slot for 6 modules Single/Dual Power Supplies
Remote Operation/Update Interface -	
Type	Ethernet, 10/100
Front Panel Indicators	Link (Green LED). Activity (Amber LED)
Connector	RJ45
Operating Temperature -	0 to 50°C
Storage Temperature -	-10 ~ 70°C
Operating Humidity -	<95%
AC Power -	
Operating Voltage	100 ~ 240VAC
PSU Max Power	120W
Line Cord	Detachable, 3-prong

Receiver Module Specification

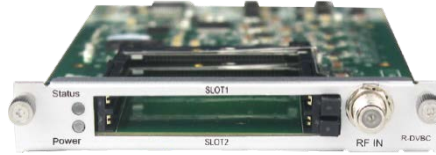

DVB-C Receiver

Input	4 channels via 1 RF Female connector
CI	2 x PCMCIA CI slots
CAM	Descrambled channel quantity depends on CAM capability, 2 CAMs could be different
QAM mode	Annex A/C
Frequency Range	47 ~ 862MHz
Bandwidth	6/7/8MHz
Constellation	16QAM / 32QAM / 64QAM / 128QAM / 256QAM
Symbol Rate	3.6 ~ 6.952Ms/s
Signal Level	40~80dBuV
CA system	Supports mainstream CAS

DTMB Receiver

Input	4 channels via 1 RF female connector
CI	2 x PCMCIA CI slots
CAM	Descrambled channel quantity depends on CAM capability, 2 CAMs could be different
Modulation Mode	TDS-OFDM
Frequency Range	47~862MHz
Constellation	4QAM-NR / 4QAM / 16QAM / 32QAM / 64QAM
Signal Level	-65~-25dm
CA System	Supports mainstream CAS

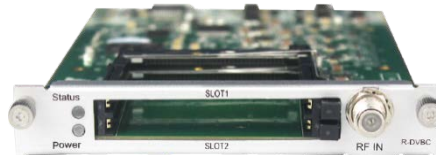

DVB-C Annex B Receiver

Input	4 channels via 1 RF Female connector
CI	2 x PCMCIA CI slots
CAM	Descrambled channel quantity depends on CAM capability, 2 CAMs could be different

QAM mode	Annex B
Frequency Range	47 ~ 862MHz
Bandwidth	6MHz
Constellation	64QAM, 256QAM
Symbol Rate	5.057Ms/s (64QAM) 5.360Ms/s (256QAM)
Signal Level	40~80dBuV
CA system	Supports mainstream CAS

ISDB-T Receiver

Input	4 channels via 1 RF Female connector
CI	2 x PCMCIA CI slots
CAM	Descrambled channel quantity depends on CAM capability, 2 CAMs could be different
Frequency Range	177.143~863.143 MHz
Bandwidth	6/7/8MHz
Constellation	DQPSK, QPSK, 16QAM, 64QAM
FEC	51/2, 2/3, 3/4, 5/6, 7/8, Automatic
Signal Level	-80~-20dBm
CA system	Supports mainstream CAS



DVB-S/S2 FTA Receiver

Input	C/Ku Bank, 4 channels via 4 RF female connectors
LNB Power	Independent power supplies for LNB-1 & LNB-3
LNB Current	Max. 400mA
LNB Voltage	13V / 18V
Constellation	QPSK, 8PSK
Frequency Range	950 - 2150MHz
Signal Level	-70~-20dBm
Roll-off Factor	0.15, 0.20, 0.25, 0.35
Symbol Rate	DVB-S: 1~45Msps DVB-S2: 1~45Msps
FEC	DV-S: 1/2, 2/3, 3/4, 5/6, 7/8 DVB-S2: 1/2, 3/5, 2/3, 3/4, 4/5, 5/6, 8/9, 9/10

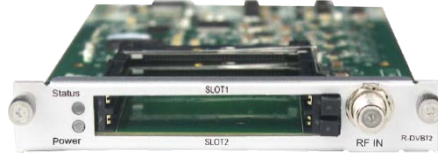

DVB-T/T2 with CI Receiver

Input	4 channels via 4 RF Female connectors
CI	2 x PCMCIA CI slots
CAM	Descrambled channel quantity depends on CAM capability, 2 CAMs could be different
Frequency Range	47 ~ 862MHz
Bandwidth	6/7/8MHz
Constellation	DVB-T: QPSK / 16QAM / 64QAM DVB-T2: QPSK / 16QAM / 64QAM / 256QAM
Guard Interval	DVB-T: 1/4, 1/8, 1/16, 1/32 DVB-T2: 1/4, 1/8, 1/16, 1/32, 1/128, 19/256, 19/128
FFT Size	DVB-T: 2K, 8K DVB-T2: 1K, 2k, 4K, 8K, 16k, 32K
Signal Level	-80~-20dBm
CA system	Supports mainstream CAS

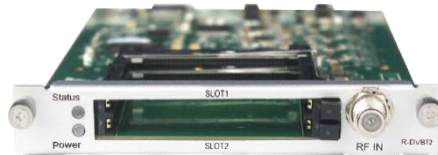

DVB-S/S2 with CI Receiver

Input	C/Ku Band, 4 channels via 2 RF Female connectors CH1 & CH2 via LNB-1 CH3 & CH4 via LNB-2
LNB Power	Independent power supplies for each LNB
LNB Voltage	13V / 18V
LNB Current	Max. 400mA
CI	2 x PCMCIA CI slots
CAM	Descrambled channel quantity depends on CAM capability, 2 CAMs could be different
Constellation	QPSK, 8PSK
Frequency Range	950 - 2150MHz
Signal Level	-70~-20dBm
Roll-off Factor	0.15, 0.20, 0.25, 0.35

Symbol Rate	DVB-S: 1~45Mpsps DVB-S2: 1~45Mpsps
FEC	DVB-S: 1/2, 2/3, 3/4, 5/6, 7/8 DVB-S2: 1/2, 3/5, 2/3, 3/4, 4/5, 5/6, 8/9, 9/10
CA System	Supports mainstream CAS



DVB-S/S2 FTA Receiver

Input	C/Ku Band, 8 channels via 8 RF female connectors
LNB Power	Independent power supplies for LNB-1 & 3, LNB-5 & LNB-7
LNB Current	13V / 18V
LNB Current	Max. 400mA
Constellation	QPSK, 8PSK
Frequency Range	950 - 2150MHz
Signal Level	-70~-20dBm
Roll-off Factor	0.15, 0.20, 0.25, 0.35
Symbol Rate	DVB-S: 1~45Mpsps DVB-S2: 1~45Mpsps
FEC	DVB-S: 1/2, 2/3, 3/4, 5/6, 7/8 DVB-S2: 1/2, 3/5, 2/3, 3/4, 4/5, 5/6, 8/9, 9/10



8VSB Receiver

Input	4 channels via 4 RF Female connectors
Frequency Range	50 - 860MHz
Bandwidth	6MHz
Modulation	8VSB
Signal Level	-80~-20dBm

Modulator Module Specification



OFDM Modulation	
Output	4/8 frequencies via 1 RF female connector 75Ω
Standard	ETSI EN 300744
Frequency Range	47 ~ 862MHz
Bandwidth	8MHz
Constellation	QPSK / 16QAM / 64QAM
Guard Intervals	1/4, 1/8, 1/16, 1/32
FFT Size	2K, 8K
Code Rates	1/2, 2/3, 3/4, 5/6, 7/8
Output Level	Max. 105dBuV
MER	≥32dB

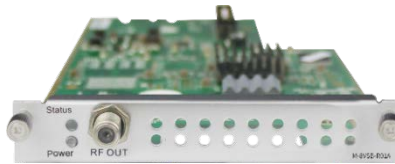

8VSB Modulation	
Output	4/8 frequencies via 1 RF female connector 75Ω
Standard	ATSC A/35
Frequency Range	50 ~ 860MHz
Bandwidth	6MHz
Constellation	8VSB
Output Level	Max. 105dBμV
MER	≥40dB



DTMB Modulation	
Output	4/8 frequencies via 1 RF female connector 75Ω
Standard	DTMB GB20600-2006
Frequency Range	47 ~ 862MHz
Constellation	4QAM-NR / 4QAM / 16QAM / 32QAM / 64QAM
Output Level	Max. 105dBμV
MER	>32dB



QAMA Modulation

Output	4/8 frequencies via 1 RF female connector 75Ω
Standard	ITU-T J.83 Annex A/C
Frequency Range	47 ~ 862MHz
Bandwidth	6/7/8MHz
Constellation	16QAM / 32QAM / 64QAM / 128QAM / 256QAM
Symbol Rate	3.6~6.9Ms/s
Output Level	Max. 105dBμV
MER	≥32dB



QAMB Modulation

Output	4/8 frequencies via 1 RF female connector 75Ω
Standard	ITU-T J.83 Annex B
Frequency Range	47 ~ 862MHz
Bandwidth	6/7/8MHz
Constellation	64QAM / 256QAM
Symbol Rate	3.6~6.9Ms/s
Output Level	Max. 105dBμV
MER	≥32dB

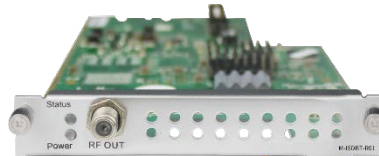

ISDB-T Modulation

Output	4/8 frequencies via 1 RF female connector, 75Ω
Standard	ARIB STD-B31
Frequency Range	57 - 860MHz
Bandwidth	6MHz
Constellation	QPSK, 16QAM / 64QAM
Transmission Mode	2K
RS Code	RS (204.188)

FEC	1/2, 2/3, 3/4, 5/6, 7/8
Guard Interval	1/4, 1/8, 1/16, 1/32
Hierarchy Mode	Layer A
Segment Mode	Full Seg
Output Level	Max. 104dB μ V
MER	\geq 40dB

Encoder Module Specification



HDMI Encoder (Commercial)

Input	4 channels via 4 HDMI female connectors (HDMI 1.4)
Video	H.264/AVC HD: MP/HP@L4.0/4.1/4.2 SD: MP/HP@L3.0/3.1/3.2
Resolution	SD: 576i50, 480i59.94 HD: 1080p@25/30, 1080i@50/59.94/60, 720p@50/60 *Output supports progressive format only, and resolution support up to 1920*1080p30
Bitrate Control	CBR
Video Bitrate	600 ~ 12,000Kbps
GOP Structure	IPPP
GOP Size	1~99
Aspect Ratio	Automatic or Manual
Audio	MPEG-1 Layer II, AAC (Optional), AC3 (Optional)
Audio Bitrate	32~384Kbps
Audio Mode	Stereo (2.0, including downmix)
Audio Sampling Rate	48KHz
Audio Volume Leveling	-20dB~20dB
OSD Overlay	Text, Image, QR Code



HDMI Encoder (Professional)

Input	4 channels via 4 HDMI female connectors (HDMI 1.4)
Video	H.264 / AVC HD: MP/HP@L4.0 SD: MP/HP@L3.0 MPEG-2 SD: MP@ML
Resolution	SD: 576i50, 480i59.94 HD: 1080p@25/30/50/59.94/60, 1080i@50/59.94/60, 720p@50/60
Bitrate Control	CBR / VBR
Video Bitrate	1,000 ~ 14,000Kbps
GOP Structure	IBBP, IPPP, IBP
GOP Size	6~63
Aspect Ratio	Automatic or Manual
Audio	MPEG-1 Layer II, AAC (Optional), AC3 (Optional)
Audio Bitrate	32~384Kbps
Audio Mode	Stereo (2.0, including downmix)
Audio Sampling Rate	48KHz
Audio Volume Leveling	-20dB~20dB



HDMI Encoder 02

Input	2 channels via 2 HDMI or 2 component female connectors (HDMI 1.4) CC/Component input via DB15 port
Video	H.264/AVC HD: MP/HP@L4.0, SD: MP/HP@L3.0 MPEG-2 SD: MP@ML HD: MP@HL
Resolution	SD: 576i50, 480i59.94f HD: 1080p25/30/50/59.94/60, 1080i50/60, 720p50/60 *The maximum output resolution is 1080i60
Bitrate Control	CBR
Video Bitrate	1000 ~ 18,000Kbps

GOP Structure	IBBP, IPPP, IBP
GOP Size	6~63
Audio	MPEG-1 Layer II, AAC (Optional), AC3 (Optional). Support AC2 pass-through and dual audio encoding.
Audio Mode	Stereo (2.0, including downmix)
Sampling Rate	48KHz



HDMI Encoder with CC

Input	2 channels via 2 HDMI female connectors (HDMI 1.4) CC via RCA connector
Video	H.264/AVC HD: MP/HP@L4.0 SD: MP/HP@L3.0 MPEG-2 SD: MP@ML HD: MP@HL
Resolution	SD: 576i50, 480i59.94 HD: 1080p@25/30/50/59.94/60, 1080i@50/60, 720p@50/60 *The maximum output resolution is 1080i60
Bitrate Control	CBR
Video Bitrate	1000 ~ 18,000Kbps
GOP Structure	IBBP, IPPP, IBP
GOP Size	6~63
Audio	MPEG-1 Layer II, AAC (Optional), AC3 (Optional). Support AC3 pass-through and dual audio encoding
Audio Mode	Stereo (2.0, including downmix)
Audio Sampling Rate	48KHz



SDI Encoder
Input

2 channels via 2 SDI or CVBS
SDI or CVBS via BNC connector
Audio via phoenix connector

Video	H.264/AVC HD: MP/HP@L4.0, SD: MP/HP@L3.0 MPEG-2 SD: MP@ML HD: MP@HL
Resolution	SD: 576i50, 480i59.94 HD: 1080p@25/30/50/59.94/60, 1080i@50/60, 720p@50/60 *The maximum output resolution is 1080i60
Bitrate Control	CBR
Video Bitrate	1000 ~ 18,000Kbps
GOP Structure	IBBP, IPPP, IBP
GOP Size	6~63
Audio	MPEG-1 Layer II, AAC (optional), AC3 (optional). Support AC3 pass-through and dual encoding
Audio Mode	Stereo (2.0, including downmix)
Audio Sampling Rate	48KHz



HEVC HDMI Encoder (8-CH)

Input	8 channels via 8 HDMI female connectors (HDMI 1.4)
Video	H.264 / AVC MP/HP@L4.2 H.265 / HEVC MP@L4.1
Resolution	HD: 1080p-29.97 / 30 / 50 / 59.94 / 60 1080i-29.97 / 30 / 50 / 59.94 / 60 720p-50 / 59.94 / 60 SD: 576i-50 576p-50 460i-59.84 / 60 460p-59.84 / 60 *Output supports progressive only, and resolution support up to 1080p30
Bitrate Control	CBR
Video Bitrate	600 ~ 20,000Kbps
GOP Structure	IPPP
GOP Size	1~60
Aspect Ratio	Automatic or Manual
Audio	MPEG-1 Layer II, AAC, AC3
Audio Bitrate	32~192Kbps
Audio Mode	Stereo 2.0

Audio Sampling Rate	48KHz
Audio Volume Leveling	-20dB~20dB
OSD overlay	Text, Image, QR Code



HEVC HDMI Encoder (4-CH)

Input	4 channels via 4 HDMI female connectors (HDMI 1.4)
Video	H.264 / AVC MP/HP@L4.2 H.265 / HEVC MP@L4.1
Resolution	HD: 1080p-29.97 / 30 / 50 / 59.94 / 60 1080i-29.97 / 30 / 50 / 59.94 / 60 720p-50 / 59.94 / 60 SD: 576i-50 576p-50 460i-59.84 / 60 460p-59.84 / 60 *Output supports progressive only, and resolution support up to 1080p30
Bitrate Control	CBR
Video Bitrate	600 ~ 20,000Kbps
GOP Structure	IPPP
GOP Size	1~60
Aspect Ratio	Automatic or Manual
Audio	MPEG-1 Layer II, AAC, AC3
Audio Bitrate	32~192Kbps
Audio Mode	Stereo 2.0
Audio Sampling Rate	48KHz
Audio Volume Leveling	-20dB~20dB
OSD overlay	Text, Image, QR Code



CVBS Encoder (Commercial)

Input	8 channels via 2 DB15 connectors, each DB15 for 4 channels 2 x RCA-DB15 adaptor cables come along with the module.
Video	H.264/AVC SD: MP/HP@L3.0/3.1/3.2
Resolution	SD: 576i50, 480i59.94
Bitrate Control	CBR

Video Bitrate	600 ~ 6,000Kbps
GOP Structure	IPPP
GOP Size	1~99
Aspect Ratio	Automatic or Manual
Audio	MPEG-1 Layer II
Audio Bitrate	32~384Kbps
Audio Mode	Stereo (2.0, including downmix)
Audio Sampling Rate	48KHz
Audio Volume Leveling	-20dB~20dB
OSD Overlay	Text, Image, QR Code



CVBS Encoder (Professional)

Input	6 channels via 2 DB15 connector, each DB15 for 3 channels 2 x RCA-DB15 adaptor cables come along with the module.
Video	H.264/AVC SD: MP/HP@L3 MPEG-2 SD: MP@ML
Resolution	SD: 576i50, 480i59.94
Bitrate Control	CBR
Video Bitrate	1000 ~ 6,000Kbps
GOP Structure	IBBP, IPPP IBP
GOP Size	6~63
Aspect Ratio	Automatic or Manual
Audio	MPEG-1 Layer II
Audio Bitrate	32~384Kbps
Audio Mode	Stereo (2.0, including downmix)
Audio Sampling Rate	48KHz
Audio Volume Leveling	-20dB~20dB

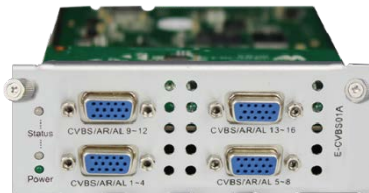

CVBS Encoder (Professional)

Input	16 channels via 4 DB15 connector, each DB15 for 4 channels 4 x RCA-DB15 adaptor cables come along with the module.
Video	H.264/AVC SD: MP/HP@L3.0/3.1/3.2

Resolution	SD: 576i50, 480i59.94
Bitrate Control	CBR
Video Bitrate	1000 ~ 8,000Kbps
GOP Structure	IPPP
GOP Size	1~99
Aspect Ratio	Automatic or Manual
Audio	MPEG-1 Layer II
Audio Bitrate	32~384Kbps
Audio Mode	Stereo (2.0, including downmix)
Audio Sampling Rate	48KHz
Audio Volume Leveling	-20dB~20dB

Function Module Specification



EAS Processing Module

Input	Digital EAS input (SCTE-18) via 1*RJ45 port Analogue EAS input via 3pin contact closure CVBS input via 1*RCA connector Audio L/R input via 2*RCA connector TS input via 1*BNC connector
Video	H.264 SD: MP/HP@L3.0 MPEG-2 SD: MP @ML (by default)
Resolution	SD: 480i59.94fps
ASI	500Kbps to 100Mbps
Contact Closure	3PIN Connector with dry Contact or 5~12V DC input for EAS trigger
RJ45	10/100M Ethernet for SCTED-18 digital EAS input
Bitrate Control	CBR
Bitrate	500~8,000Kbps
GOP Structure	IBBP, IPPP, IBP
GOP Size	6~63
Audio	MPEG-1 Layer II, AAC-LC/HE, AC3
Audio Mode	Stereo (2.0, including downmix)
Sampling Rate	48KHz

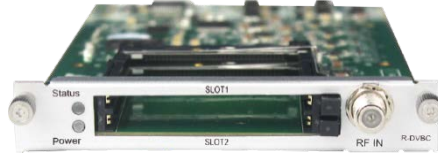

CI Scrambler/Descrambler

Standard	EN 50221
Interface	2 x PCMCIA CI Slots
CAM Scrambling	Support Xcrypt CAS
CAM Descrambling	Supports mainstream CAS
	Descrambled channel quantity depends on CAM capability
	2 CAMs could be different

APPENDIX D - Warranty

Sencore warrants this instrument against defects from any cause, except acts of God and abusive use, for a period of 1 (one) year from date of purchase. During this warranty period, Sencore will correct any covered defects without charge for parts, labor, or recalibration.

APPENDIX E - Support and Contact information

1 Returning for Service or Calibration

The OmniHub 6/6is a delicate piece of equipment and needs to be serviced and repaired by Sencore. Periodically it is necessary to return a product for repair or calibration. In order to expedite this process please carefully read the instructions below.

2 RMA Number

Before any product can be returned for service or calibration, an RMA number must be obtained. In order to obtain a RMA number, use the following steps:

1. Contact the Sencore service department by going online to www.sencore.com and select Support.
2. Select Service and Repair from the options given.
3. Fill in the following required information:
 - i. First & Last Name
 - ii. Company
 - iii. Email
 - iv. Phone Number
 - v. Ship and Bill to Address
 - vi. Unit Model and Serial Numbers
4. A RMA number will be emailed to you with return instruction shortly after the form is completed.

3 Shipping the Product

Once an RMA number has been issued, the unit needs to be packaged and shipped back to Sencore. It's best to use the original box and packaging for the product but if these are not available, check with the customer service representative for the proper packaging instructions.

Note: DO NOT return any power cables or accessories unless instructed to do so by the customer service representative.