



MRD 4400 Modular Receiver

User Manual



Copyright

© 2017 Sencore, Inc. All rights reserved.
3200 Sencore Drive, Sioux Falls, SD USA
www.sencore.com

This publication contains confidential, proprietary, and trade secret information. No part of this document may be copied, photocopied, reproduced, translated, or reduced to any machine-readable or electronic format without prior written permission from Sencore. Information in this document is subject to change without notice and Sencore Inc. assumes no responsibility or liability for any errors or inaccuracies. Sencore, Sencore Inc, and the Sencore logo are trademarks or registered trademarks in the United States and other countries. All other products or services mentioned in this document are identified by the trademarks, service marks, or product names as designated by the companies who market those products. Inquiries should be made directly to those companies. This document may also have links to third-party web pages that are beyond the control of Sencore. The presence of such links does not imply that Sencore endorses or recommends the content on those pages. Sencore acknowledges the use of third-party open source software and licenses in some Sencore products. This freely available source code can be obtained by contacting Sencore Inc.

About Sencore

Sencore is an engineering leader in the development of high-quality signal transmission solutions for the broadcast, cable, satellite, IPTV, telecommunications, and professional audio/video markets. The company's world-class portfolio includes video delivery products, system monitoring and analysis solutions, and test and measurement equipment, all designed to support system interoperability and backed by best-in-class customer support. Sencore meets the rapidly changing needs of modern media by ensuring the efficient delivery of high-quality video from the source to the home. For more information, visit www.sencore.com.

Revision History

Date	Version	Description	Author
01/29/2013	0.1	First Draft	ACD
02/04/2013	1.0	Initial Release	ACD
04/18/2013	1.1	Specification Edits and GUI Changes	ACD
06/19/2013	1.2	Specification Addition/ Edits, GUI Changes,	GAK
06/25/2013	1.3	Edit & Updates for ver. 1.1.2 Release	GJL
07/10/2013	1.4	Edits	GJL
08/30/2013	1.5	Update for ver. 1.2.0 Release	NGJ
11/21/2013	1.6	Update for ver. 1.3.0 Release	NGJ
2/28/2014	1.7	Update for ver. 1.4.0 Release	CDP
5/14/2014	1.8	Update for ver. 2.0.0 Release	CDP
6/17/2014	1.9	Update for ver. 2.0.2 Release	CDP
9/18/2014	1.10	Update for ver. 2.1.0 Release	CDP
11/1/2014	1.11	Update for ver. 2.2.0 Release	CDP
2/24/2014	1.12	Update for ver. 2.2.2 Release	JDF
3/12/2015	1.13	Update for ver. 2.3.0 Release	CDP
7/8/2015	1.14	Update for ver. 2.4.0 Release	CDP
10/21/2015	1.15	Update for ver. 2.5.0 Release	CDP
3/1/2016	1.16	Update for ver. 3.0.0 Release	CDP
6/6/2016	1.17	Update for ver. 3.1.0 Release	CDP
9/28/2016	1.18	Update for ver. 3.2.0 Release	CDP
4/07/17	1.19	Update for 3.3.0 Release	ACD

Safety Instructions

- Read these instructions
- Keep these instructions
- Heed all warnings
- Follow all instructions
- Do not use this apparatus near water
- Clean only with dry cloth
- Do not block any ventilation openings. Install in accordance with the manufacturer's instructions
- Do not install near any heat sources such as radiators, heat registers, stoves, or other apparatus (including amplifiers) that produce heat
- Do not defeat the safety purpose of the polarized or grounding-type plug. A polarized plug has two blades with one wider than the other. A grounding type plug has two blades and a third grounding prong. The wide blade or the third prong is provided for your safety. If the provided plug does not fit into your outlet, consult an electrician for replacement of the obsolete outlet.
- Protect the power cord from being walked on or pinched particularly at plugs, convenience receptacles, and the point where they exit from the apparatus.
- Only use attachments/accessories specified by the manufacturer.
- Unplug this apparatus during lightning storms or when unused for long periods of time.
- Refer all servicing to qualified service personnel. Servicing is required when the apparatus has been damaged in any way, such as power-supply cord or plug is damaged, liquid has been spilled or objects have fallen into the apparatus, the apparatus has been exposed to rain or moisture, does not operate normally, or has been dropped.
- Do not expose this apparatus to dripping or splashing and ensure that no objects filled with liquids, such as vases, are placed on the apparatus.
- To completely disconnect this apparatus from the AC Mains, disconnect the power supply cord plug from the AC receptacle.
- The mains plug of the power supply cord shall remain readily operable.
- **Damage Requiring Service:** Unplug this product from the wall outlet and refer servicing to qualified service personnel under the following conditions:
 - When the power-supply cord or plug is damaged.
 - If liquid has been spilled, or objects have fallen into the product.
 - If the product has been exposed to rain or water.
 - If the product does not operate normally by following the operating instructions. Adjust only those controls that are covered by the operating instructions as an improper adjustment of the controls may result in damage and will often require extensive work by a qualified technician to restore the product to its normal operation.
 - If the product has been dropped or damaged in any way.
 - The product exhibits a distinct change in performance.
- **Replacement Parts:** When replacement parts are required, be sure the service technician uses replacement parts specified by Sencore, or parts having the same operating characteristics as the original parts. Unauthorized part substitutions made may result in fire, electric shock or other hazards.

SAFETY PRECAUTIONS

There is always a danger present when using electronic equipment.

Unexpected high voltages can be present at unusual locations in defective equipment and signal distribution systems. Become familiar with the equipment that you are working with and observe the following safety precautions.

- Every precaution has been taken in the design of your MRD 4400 to ensure that it is as safe as possible. However, safe operation depends on you the operator.
- Always be sure your equipment is in good working order. Ensure that all points of connection are secure to the chassis and that protective covers are in place and secured with fasteners.
- Never work alone when working in hazardous conditions. Always have another person close by in case of an accident.
- Always refer to the manual for safe operation. If you have a question about the application or operation call Sencore for assistance.
- **WARNING** – To reduce the risk of fire or electrical shock never allow your equipment to be exposed to water, rain or high moisture environments. If exposed to a liquid, remove power safely (at the breaker) and send your equipment to be serviced by a qualified technician.
- To reduce the risk of shock the MRD 4400 must be connected to a mains socket outlet with a protective earthing connection.
- For the MRD 4400 the mains plug is the main disconnect and should remain readily accessible and operable at all times.
The MRD 4400 is equipped with an internal system battery. The MRD 4400 must be sent to Sencore service for replacement of this battery.
- When installing the MRD 4400 utilizing the DC power supply, the power supply **MUST** be used in conjunction with an over-current protective device rated at 50 V, 5 A, type: Slow-blo, as part of battery-supply circuit.
- To reduce the risk of shock and damage to equipment, it is recommended that the chassis grounding screw located on the rear of the MRD 4400 – be connected to the installation's rack, the vehicle's chassis, the battery's negative terminal, and/or earth ground.

CAUTION – Danger of explosion if battery is incorrectly replaced. Replace only with the same or equivalent type.

FCC Class A Information

The MRD 4400 has been tested and found to comply with the limits for a Class A digital device, pursuant to Part 15 of the FCC Rules. These limits are designed to provide reasonable protection against harmful interference when the equipment is operated in a commercial environment. This equipment generates, uses, and can radiate radio frequency energy and, if not installed and used in accordance with the instructions, may cause harmful interference to radio communications. Operation of this equipment in a residential area is likely to cause harmful interference in which case the user will be required to correct the interference at his or her own expense.

Shielded cables must be used with this unit to ensure compliance with the Class A FCC limits.

⚠ Warning: Changes or modifications to this unit not expressly approved by the party responsible for compliance could void the user's authority to operate the equipment.

Dolby Digital Information

This product has been manufactured under license from Dolby Laboratories.

“Dolby Digital”, “AC-3”, and “Dolby Digital Plus” are licensed trademarks of Dolby Laboratories.

Package Contents

The following is a list of the items that are included along with the MRD 4400:

1. Declaration of Conformity
2. AC Power Cable
3. Quick Start Guide

Note: If any option cables were ordered with the MRD 4400, they will be included in the box as well.

If any of these items were omitted from the packaging of the MRD 4400 please call 1-800-SENCORE to obtain a replacement. Manuals for Sencore products can be downloaded at www.sencore.com

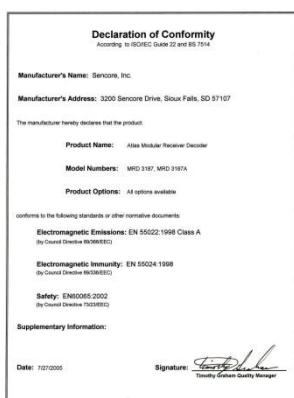

1) Declaration of Conformity



2) AC Power Cable

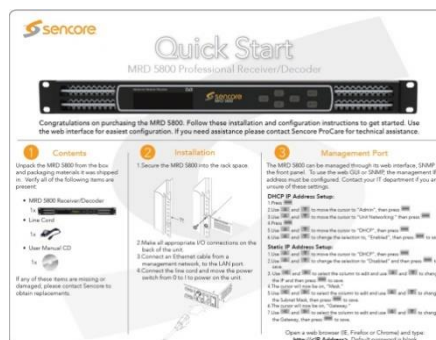

3) Quick Start Guide

Table of Contents

Section 1 Overview	10
1.1 Product Introduction.....	11
1.2 Front Panel Overview	11
1.3 Rear Panel Overview.....	11
1.4 Cooling.....	12
1.5 Rack Information.....	12
Section 2 Installation	13
2.1 Rack Installation	14
2.2 Power Connection	14
2.3 AC Power Connection	14
2.4 AC Dual Redundant Power Connection (optional)	15
2.5 DC Power Connection	15
2.6 Maintenance	15
2.7 Network Setup via Front Panel.....	15
Section 3 Operating the Front Panel	18
3.1 MRD 4400 Front Panel Overview.....	19
Section 4 Operating the Web Interface	21
4.1 MRD 4400 Web Interface Overview.....	22
4.1.1 Logging into the MRD 4400 Web Interface	22
4.1.2 Hiding Unused Inputs	22
4.1.3 Buttons and Status Indicators.....	22
4.1.4 Drag and Drop Menus	23
4.2 Main Panel.....	24
4.2.1 Configuring Active Inputs.....	25
4.2.2 Configuring ASI Input	27
4.2.3 Configuring MPEG/IP Input	28
4.2.4 Configuring DVB-S/S2/S2X Input.....	31
4.2.5 Configuring DVB-S/S2 Input.....	32
4.2.6 Configuring 8VSB/QAM Input.....	34
4.2.7 Configuring Turbo PSK Input	35
4.2.8 Configuring DVB-T2/C2/ISDB-T Input.....	37
4.2.9 Configuring DVB-CI Descrambling.....	39
4.2.10 Configuring BISS Descrambling.....	41
4.2.11 Configuring Service Selection	43
4.2.12 Configuring Video Services	47
4.2.13 Configuring Secondary Video Services.....	49
4.2.14 Configuring Audio	51
4.2.15 Configuring Genlock	53
4.2.16 SCTE35	54
4.2.17 ESAM.....	57
4.2.18 Configuring Ancillary Data Options	59
4.2.19 Configuring SDI Outputs Port 1 & 2	60
4.2.20 Configuring SDI Audio Embedding.....	66
4.2.21 Configuring Secondary SDI Outputs	67
4.2.22 Configuring Secondary SDI Audio Embedding	70
4.2.23 Configuring Composite Output	72
4.2.24 Configuring Analog Audio Output.....	73
4.2.25 Configuring Digital Audio Output	74
4.2.26 PID Filter.....	74

4.2.27	Configuring ASI Output.....	75
4.2.28	Configuring the MPEG/IP Outputs	76
4.2.29	Configuring the MPEG/IP MPE Outputs.....	78
4.2.30	Viewing PSIP Information.....	80
4.3	Admin Panel	81
4.3.1	Changing Unit Password	83
4.3.2	Profiles.....	83
4.3.3	General Settings.....	84
4.3.4	Unit Network Configuration.....	85
4.3.5	MPEG/IP Network Configuration	86
4.3.6	Licensing.....	87
4.3.7	Date/Time	88
4.3.8	Configuring SNMP	89
4.3.9	Syslog.....	91
4.3.10	In-Band Control	92
4.3.11	Updating the MRD 4400	92
4.3.12	Reboot Unit.....	94
4.3.13	Reset Defaults	94
4.4	Reporting Panel	95
4.4.1	Active Alarms.....	95
4.4.2	Event Logs.....	96
4.4.3	Configuring the Logs	97
4.5	About Panel	98
Section 5 Appendices.....		99
Appendix A	– Acronyms and Glossary	100
Appendix B	– Error and Event List.....	103
Appendix C	– Specifications.....	106
Appendix D	– Pinouts for Analog Audio and Relay Connectors	117
Appendix E	– MRD 4400 Audio Explanation	119
Appendix F	– MRD 4400 Discrete Audio Configuration	122
Appendix G	– Open Source Software.....	123
Appendix H	– Warranty	125
Appendix I	– Support and Contact Information	125

Section 1 Overview



Introduction

This section includes the following topics:

1.1	Product Introduction.....	11
1.2	Front Panel Overview	11
1.3	Rear Panel Overview.....	11
1.4	Cooling.....	12
1.5	Rack Information.....	12

1.1 Product Introduction

The MRD 4400 Receiver Decoder is the latest in Sencore's long line of professional integrated receiver/decoders for distribution and monitoring applications. Latest-generation components ensure that the MRD 4400 provides the most complete feature set and the best value for a broad swath of common receiver/decoder applications. The product supports decoding of SD or HD video, encoded as either MPEG-2 or H.264, as well as up to four audio services.

The additional audio handling capability makes the MRD 4400 the perfect solution for video distributors looking to meet upcoming descriptive video requirements, while continuing to support surround, stereo, and SAP services. The product also supports professional-grade downscaling at no additional charge for providers continuing to support legacy equipment or SD tiers. As customer demands evolve, units purchased for SD applications can be upgraded to HD output via a simple software license.

With built-in ASI input/output capability, as well as available satellite and IP interfaces, the 4400 is adaptable to most decoder use cases. The receiver also maintains Sencore's long tradition of ease of use, with a web interface accessible via all major browsers and complete control of the unit via the front panel keypad, and is backed by Sencore's best-in-class ProCare support.

1.2 Front Panel Overview

The MRD 4400 can be controlled from the front panel using the LCD screen and buttons that are shown below. A detailed description of using the front panel can be found in Section 3.1. All hardware listed below comes standard except for the DVB-CI slots which are a factory installed option.



1. LCD screen
2. Input Indicator
3. Error Indicator
4. Up, Down, Left, Right buttons
5. Back and Enter Buttons
6. 2x DVB-CI Slots (Factory Option)

1.3 Rear Panel Overview

The MRD 4400 comes standard with all of the hardware listed below except where noted as a factory installed option. The two option cards available for the MRD 4400 are the Quad Input DVB-S/S2 card or dual port MPEG/IP Input/Output card. ASI is the standard input on all MRD 4400 units. The external genlock reference connection is also a factory installed option.



1. RJ45 Management Port
2. Relay Output Connector
3. External Genlock Reference Input (Factory Option)
4. Four Digital Audio Outputs
5. Two 15-Pin Analog Audio Connectors
6. Composite Video Output
7. Two HD/SD-SDI Output Connectors (mirrored)
8. Digital Video Output Connector
9. ASI I/O Connectors
10. Option Card Slot #1 (factory installed)
11. Option Card Slot #2 (factory Installed)
12. Chassis ground
13. Optional Dual Power Supply
14. Optional Simultaneous SD Video Card (factory installed)

1.4 Cooling

The MRD 4400 is cooled via forced induction through the front of the unit and exhausted through the vents in the rear of the chassis. The MRD 4400 is equipped with a temperature controlled status indicator. If the temperature inside the unit exceeds 60° C the red “Error” text will illuminate on the front panel and a description of the error will appear in the “Error List.”

1.5 Rack Information

The MRD 4400 is intended to be mounted in a standard 19” rack. It occupies 1RU of rack space and the connections are all on the rear of the unit.

Section 2 Installation



Introduction

This section includes the following topics:

2.1	Rack Installation	14
2.2	Power Connection	14
2.3	AC Power Connection	14
2.4	AC Dual Redundant Power Connection (optional)	15
2.5	DC Power Connection	15
2.6	Maintenance	15
2.7	Network Setup via Front Panel	15

2.1 Rack Installation

To install the MRD 4400 into a rack use the following steps:

1. Determine the desired position in the rack for the MRD 4400 making sure that the air intake on the front of the unit and the exhausts on the sides of the unit will not be obstructed.
2. Insert the rack mount clips into place over the mounting holes in the rack.
3. Slide the MRD 4400 into position in the rack.
4. Secure the MRD 4400 to the rack by installing the four supplied screws through the front mounting holes and tightening.
5. If needed, secure a grounding wire use the grounding location on the rear panel of the MRD 4400. See Section 1.3 for grounding location.

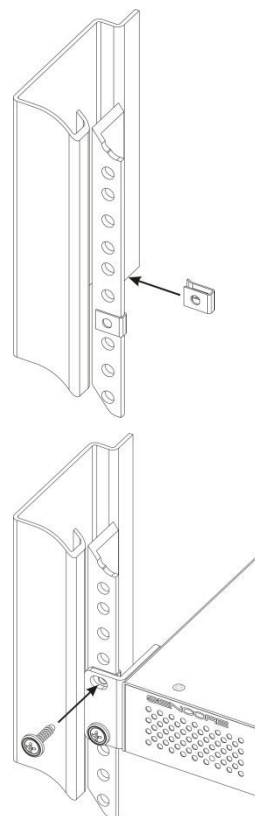

2.2 Power Connection

Using the proper power connections is vital to the safe operation of the MRD 4400. Only use the supplied 3-prong power connector or one with equal specifications. NEVER tamper with or remove the 3rd – prong grounding pin. This could cause damage to the MRD 4400, personnel, or property.

2.3 AC Power Connection

The MRD 4400 is intended for use on either 120V or 240V systems. The power supply will automatically detect the system it is connected to. To hook up the power use the following steps:

1. Locate the AC power cord that was included with the MRD 4400.
2. Plug the female end of the power cord (end with no prongs) into the back of the unit.
3. Locate a protected outlet (usually inside of the rack) to plug the male end of the power cable into.

2.4 AC Dual Redundant Power Connection (optional)

The Dual Redundant option allows the MRD 4400 to be powered by two separate supplies either operating 120V or 240V systems. The power supply will automatically detect the system it is connected to. To hook up the power use the following steps:

1. Locate the AC power cord that was included with the MRD 4400.
2. Plug the female end of the power cord (end with no prongs) into the back of the unit.
3. Locate a protected outlet (usually inside of the rack) to plug the male end of the power cable into.

2.5 DC Power Connection

The MRD 4400 with the DC chassis option is intended for use on 48V DC systems. A power cable is not included for this option. In order to apply power to the unit in this configuration, simply connect the screw terminals on rear of the unit to the rack's DC power rails.

Be sure that the power source and cable is used in conjunction with an over-current protective device rated at 50 V, 5 A, type: Slow-blo fuse as part of battery-supply circuit. Also, to reduce the risk of shock and damage to equipment, it is recommended that the chassis grounding screw (1.3) located on the rear of the MRD 4400 – be connected to the installation's rack, battery negative terminal, and/or earth ground.

2.6 Maintenance





The MRD 4400 is virtually a maintenance-free piece of equipment. There are no user serviceable parts on the inside of the unit

2.7 Network Setup via Front Panel



The MRD 4400 can be setup on a network connection to allow remote management and SNMP configuration. For these features to work, the network settings for the MRD 4400 must first be configured properly for the network it is connected to.

Static IP Address

To setup the MRD 4400 with a static IP address, use the following steps:

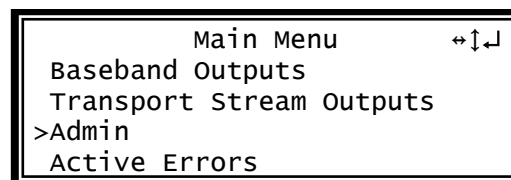
1. Press the  button.
2. Use the  and  buttons to move the cursor to "Admin", then press the  button.







3. Use the  and  buttons to move the cursor to “Unit Networking”, then press the  button.

```

Admin                                     ↔↓↵
>Unit Networking
System Time
About System
Voltage Levels

```



Note: The first menu displayed is status menu. In order to begin making changes to networking settings press the  button.

4. Use the  and  buttons to move the cursor to “DHCP”, then press the  button.



```

Configure Network                       ↔↓↵
Host Name: .....
>DHCP: Disabled

```

5. Use the  and  buttons to change the selection to “Disabled” then press the  button.





IP Address/Subnet Mask/Gateway

1. Use the  and  buttons to move the cursor to “IP”, then press the  button.

```

Configure Network                       ↔↓↵
Host Name: .....
DHCP: Disabled
>IP: 0.0.0.0
Mask: 0.0.0.0





```

2. Use the  and  buttons to select the column to edit and use the  and  buttons to change the IP, then press the  button to save the selection.

```

Configure Network                       ↔↓↵
Host Name: .....
DHCP: Disabled
>IP: 000.000.000.000
Mask: 0.0.0.0





```

3. The cursor will now be on “Mask”.
4. Use the  and  buttons to select the column to edit and use the  and  buttons to change the Subnet Mask, then press the  button to save the selection.

```

Configure Network                       ↔↓↵
Host Name: .....
DHCP: Disabled
IP: 0.0.0.0
>Mask: 000.000.000.000

```

5. The cursor will now be on “Gateway”.
6. Use the  and  buttons to select the column to edit and use the  and  buttons to change the Gateway, then press the  button to save the selection.







```

Configure Network  ↕↔↵
DHCP: Disabled
IP: 0.0.0.0
Mask: 0.0.0.0
>Gateway: 000.000.000.000

```

DHCP

The MRD 4400 can be configured to use DHCP to obtain an IP address/Subnet Mask/Gateway.

1. Use the  and  buttons to move the cursor to “DHCP:” then press the  button.
2. Use the  and  buttons to change the selection to “Enabled” then press the  button to save the selection.

```

Configure Network  ↕↔↵
Host Name: -----
>DHCP: Enabled

```

Note: It may take up to a minute for the MRD 4400 to obtain an IP address. During this time the unit will display a “busy” message next to DHCP.

Section 3 Operating the Front Panel



Introduction

This section includes the following topics:

3.1	MRD 4400 Front Panel Overview	19
-----	-------------------------------------	----

3.1 MRD 4400 Front Panel Overview



The MRD 4400 front panel allows the user to configure all settings that are present in the web interface using the buttons located on the front of the unit. The screen below is the idle screen of the MRD 4400. This idle screen allows the user to view the incoming bitrate of the active input, which input is set to active, the management IP address of the unit and the service currently set to decode.

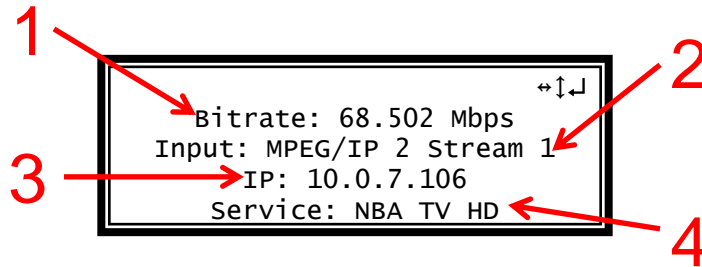

1. Bitrate of incoming stream displayed in Mbps.
2. Current active input.
3. IP address of management port.
4. Current decoded service.

The following figure shows a typical screen on the front panel. Several important features have been circled and noted below. These features are common to all screens and assist when navigating, viewing and editing unit information. The **BACK** button allows the user to return to the home screen, cancel settings and go back a menu. In order to edit a selected parameter the **ENTER** button must be pressed. Once a parameter has been changed the **ENTER** button must be pressed again before the change takes effect on the unit.

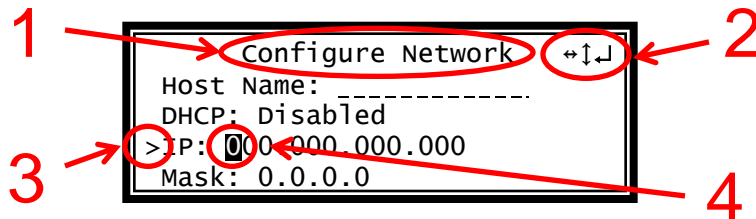

1. Screen title.
2. Icons indicate which control buttons are currently valid for entry.

3. Cursor shows which line is active.
4. When editing, active character or item is highlighted.

Section 4 Operating the Web Interface



Introduction

This section includes the following topics:

4.1	MRD 4400 Web Interface Overview	22
4.2	Main Panel	24
4.3	Admin Panel	81
4.4	Reporting Panel	95
4.5	About Panel	98

4.1 MRD 4400 Web Interface Overview

4.1.1 Logging into the MRD 4400 Web Interface



To open the MRD 4400 web interface use one of the following supported browsers and navigate to the unit's IP address:

- Internet Explorer 7 & above
- Firefox 3.5 & above
- Google Chrome

The user will need to login to the web interface. By default the admin user account is available without a password. Press the login button in order to login to the web interface.





4.1.2 Hiding Unused Inputs

The MRD 4400 web interface allows the user to hide inactive inputs using the  Hide Unused button or show all available inputs by click the  Show Unused button. Only the inputs configured as the Primary Input and Backup Input (see Section 4.2.1) in the will be displayed when unused inputs are hidden.

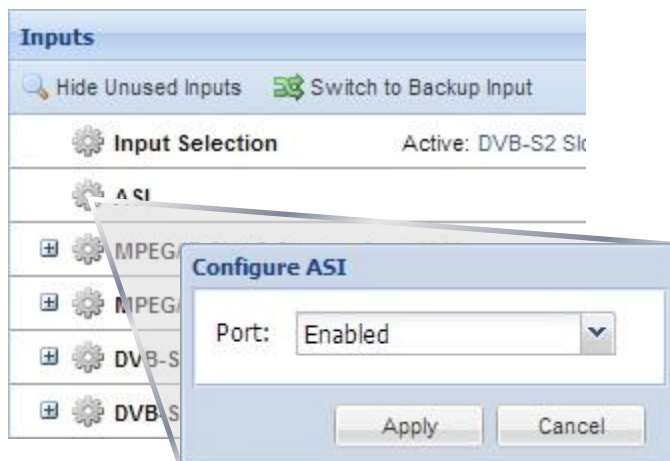

4.1.3 Buttons and Status Indicators

When the  icon is shown user configuration is available. Clicking this button will open menus where settings can be changed by the user.



When the  icon is shown additional status information can be viewed. Click this button will expand the menu to display the additional status information. All text in status menus shown in **ORANGE** are user configurable settings. Text shown in **BLUE** is not user configurable and is strictly a status or value. To minimize the status windows again click the  icon.

Status in the MRD 4400 web interface is shown with LED status indicators:

Green LED		Status is good. No errors are present and function is operating normally.
Red LED		Status indicates function is affected by active error. To view the errors navigate to Alarms panel to view Active Errors.
Grey LED		Status is inactive. Function is currently disabled or unavailable.

4.1.4 Drag and Drop Menus

Certain menus in the MRD 4400 allow the user to drag and drop items to auto populate fields. Conditional Access and Service Selection menus are some examples of menus that drag and drop can be used. In the example below a service in the transport stream view on the right hand side of the window is selected and dragged over to auto populate the PIDs in the service selection section.

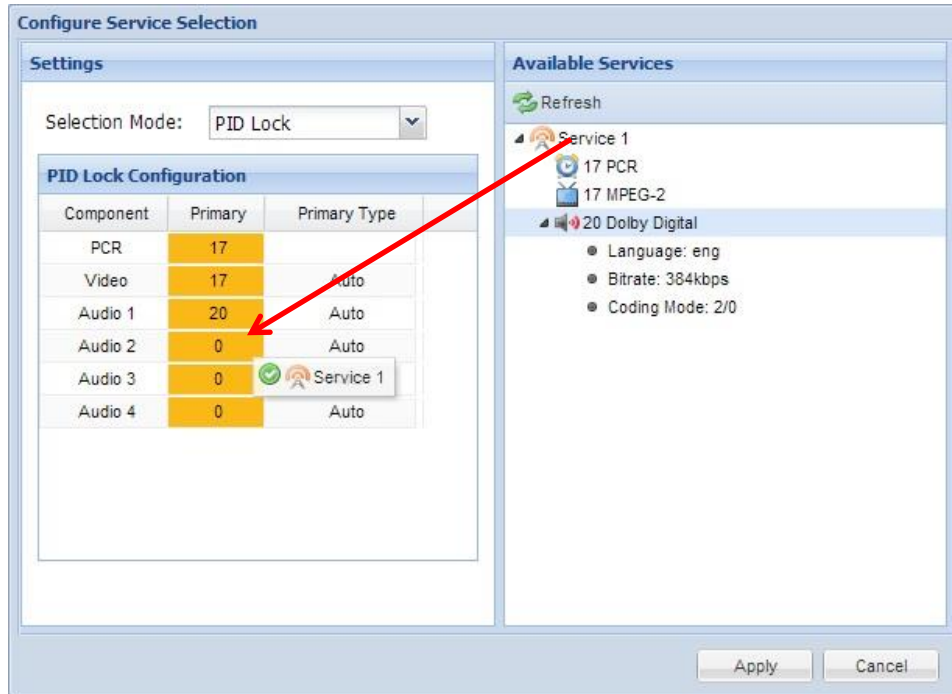



4.2 Main Panel

The Main panel of the MRD 4400 web interface is used to configure the unit to decode, de-encapsulate and demodulate. When configuring the MRD 4400 the user begins at the top of the menu and works down. The inputs are configured, then descrambling (if present), then service or PIDs are selected for decode, then outputs are configured. Pictured below is a fully populated unit with all options licensed.

The screenshot displays the 'Main Control Panel' of the MRD 4400 device. It features a navigation bar with 'Main', 'Admin', 'Reporting', and 'About' tabs. The main content is organized into several sections:

- Inputs:** Includes a 'Show Unused Inputs' button and a 'Switch to Backup Input' button. The 'Input Selection' row shows 'Active: DVB-S2 Slot 1 Port A', 'Primary: DVB-S2 Slot 1 Port A', and 'Backup: None'. Below it, a row for 'DVB-S2 Slot 1 Port A' displays '3974.0 MHz', 'Level: -57 dBm', 'Eb/No: 14.1 dB', 'Link Margin: 8.1 dB', and '9.100 Mbps' with a green status indicator.
- Conditional Access:** Contains 'BISS' (Operation Mode: Disabled) and 'DVB-CI' (Bottom Slot (None): Disabled, Top Slot (None): Disabled).
- Transport Stream Processing:** Lists 'SCTE35' and 'ESAM'.
- Decoding:** Shows 'Service' (Service: 2 (MEBv2), Mode: Service Lock, On Backup: Use Primary Service) and a list of streams: 'Video' (PID: 456, Native Format: 720x480i 4x3 29.97fps, Video Bitrate: 3.323 Mbps), 'Audio 1' (PID: 458, Format: 192 kbps 48.0 kHz 2/0, DialNorm: 27), 'Audio 2' (PID: 459, Format: 192 kbps 48.0 kHz 2/0, DialNorm: 27), and 'SCTE35' (PID: 802, Section Presence: Not Present).
- Baseband Processing:** Includes 'Video' (Output Format: 720x480i 4x3 29.97fps), 'Audio', 'Genlock' (External Format: None, Ref. Source: Disabled, Color Reference: Not Present), and 'Ancillary Data'.
- Baseband Outputs:** Lists 'SDI', 'Composite', 'Analog Audio', and 'Digital Audio'.
- Transport Stream Outputs:** Features a 'Show Unused Outputs' button, 'PID Filter', and 'ASI' (Source: Descrambled and Processed, 9.100 Mbps) with a green status indicator.

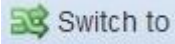
4.2.1 Configuring Active Inputs

This menu allows the user to configure a primary and backup input. In case there is an input failover the MRD 4400 is capable of detecting the failed state and switching to a secondary backup input in order to provide a continuous output. Which input is primary and backup, how the inputs switchover and restore and switchover timing is all user configurable. The user can force the MRD 4400 to switch between the Primary and Backup Inputs by clicking the  button. To change the active input and failover settings click the  icon next to Input Selection:

Inputs			
Hide Unused Inputs		Switch to Primary Input	
Input Selection	Active: ASI	Primary: DVB-S2 Slot 1 Port A	Backup: ASI
ASI			
MPEG/IP Slot 2 Stream 1	*:5000	Packet Status: Not Present	FEC: Not Present
MPEG/IP Slot 2 Stream 2	239.192.0.200:10000	Packet Status: Not Present	FEC: Not Present
DVB-S2 Slot 1 Port A	4140.0 MHz	Level: -55 dBm	C/N: 16.7 dB Link Margin:

Active Input Indicator

Configure Inputs

Primary Input:

Backup Input:

Switch On:

Restore On:

Switchover (secs.):

Active Input and Failover Configuration Menu

Setting	Range	Description
Primary Input	ASI	Used for both normal operation and input failover settings. During normal operation this input will be the active input.
	MPEG/IP Slot X Stream X	
	DVB-S2 Slot X Port X	
	DVB-S2X Slot X Stream X	
	8VSB/QAM Slot X	
	Turbo PSK Slot X	
	DVB-T2/C2/ISDB-T Slot X	
Backup Input	None	During failover operation this input will become the active input. The catalyst for what causes the unit to switch to this input is configured in the following setting.
	ASI	
	MPEG/IP Slot X Stream X	
	DVB-S2 Slot X Port X	
	DVB-S2X Slot X Stream X	
	Turbo PSK Slot X	

	DVB-T2/C2/ISDB-T Slot X	
	None	
Switch On	Manual Only TS Sync Loss Decode Failure	<p><i>Manual Only:</i> the unit will not switch inputs automatically. The user must manually switch inputs.</p> <p><i>TS Sync Loss:</i> the MRD 4400 will switch from the primary to the backup input if the primary stream loses synchronization for the duration of the Switchover Interval.</p> <p><i>Decode Failure:</i> the unit will switch to the backup input when it encounters decoding errors on the primary input.</p>
Restore On	Manual Only Primary Input TS Restored Backup Input TS Sync Loss Decode Failure	<p><i>Manual Only:</i> the unit will not restore to the primary input automatically. The user must manually switch inputs.</p> <p><i>Primary Input TS Restored:</i> the MRD 4400 restores to primary when the Primary input regains transport stream synchronization.</p> <p><i>Backup Input TS Sync Loss:</i> the unit will switch from backup to primary when the backup stream loses synchronization for the duration of the Switchover interval.</p> <p><i>Decode Failure:</i> the unit restores to the Primary Input when the Backup Input experiences a decoding error.</p>
Switchover	1-20 seconds	The time in seconds which <i>Switch On</i> or <i>Restore On</i> value must remain in the configured state before the MRD 4400 switches between the Primary Input and Backup Input or vice versa.

4.2.2 Configuring ASI Input

This menu allows the user to either Enable or Disable the ASI Input on the MRD 4400. Beginning with revision J main boards the ASI ports can be configured as either an input or output. Earlier revision remain configured as 1 input and 1 output port. Main board version can be located on the about tab under the Options section.

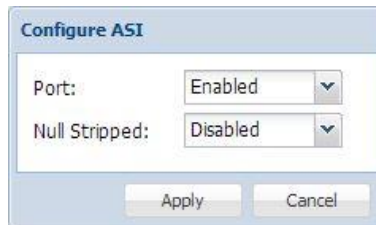

Rev I and earlier main board ASI options

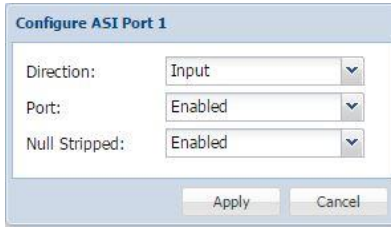

Rev J and later main board ASI options

Setting	Range	Description
Direction	Input Output	Configure the ASI port to either an input or an output. Applies only to main board revision J or later. Main board version can be located on the about tab under the Options section.
Port	Enabled Disabled	This setting allows the user to enable or disable the ASI Input to the MRD 4400.
Null Stripped	Disabled Enabled	Enabling Null Stripped allows the MRD 4400 to receive streams that do not contain null packets. (i.e. VBR Transport Streams)

4.2.3 Configuring MPEG/IP Input

If the MPEG/IP Input card was selected as a factory installed option, the following menus and options will be available for configuration. This menu allows the user to configure the MPEG/IP inputs. Each MPEG/IP card has two ports that can be set to receive and/or transmit. This menu is for setting up the reception of MPEG/IP unicast or multicast transport streams. The menu for Stream 1 and 2 have the same settings. IGMPv2 is used to join/leave multicast streams by default if no IGMP Filter addresses are entered. If IGMP Filter Mode addresses are specified then IGMPv3 is used.

General and Advanced options for IP input

Setting	Range	Description
Receive	Enabled Disabled	This setting allows the user to enable or disable these input stream settings.
Physical Connector	Port 1 Port 2	The physical connector on the MPEG/IP card that will be used to receive the input.
Mode	Multicast Unicast	<i>Multicast</i> setting allows the unit to receive multicast streams. Multicast streams originate from the IP range 224.0.0.0 – 239.255.255.255. <i>Unicast</i> allows the unit to receive unicast streams. Unicast streams originate directly from a source device.
Destination IP	224.0.0.0 – 239.255.255.255	This setting is only available when receiving a multicast stream. This address is the IP address the source device is sending to.
Destination Port	0 - 65535	This is the UDP port the source device is sending to. This is the only setting required to receive a unicast stream.

Internal Source Filter	Enabled Disabled	Enabling Source filtering disables IGMP V3 filtering and allows a user to whitelist a single IP address for a given multicast and block all other source IP's
Internal Source Filter IP	0.0.0.0 – 255.255.255.255	Source IP for whitelist. All other source IP addresses are blocked
IGMP Filter Mode	Exclude Include	Used on networks supporting IGMPv3. If this setting is set to <i>Exclude</i> any streams originating from the user defined IP addresses will be rejected. If this setting is set to <i>Include</i> any streams originating from the user defined IP addresses will be received.
FEC	Enabled Disabled	Enabling FEC (Forward Error Correction) tells the MRD 4400 to look at Destination Port +2 and Destination Port +4 for a SMPTE 2022 FEC Matrix.
Null Stripped	Enabled Disabled	Enabling Null Stripped allows the MRD 4400 to receive streams that do not contain null packets. (i.e. VBR TS Streams)
RTP SSRC	Enabled Disabled	Enabling RTP SSRC allows the MRD 4400 to filter the input by the user defined value. Only streams containing the user defined value will be received by the MRD 4400.
SSRC Filter Value	0 - 4294967295	The Filter Value the MRD 4400 checks for before receiving a stream with RTP SSRC.
Buffer Mode	Size (KB) Delay (ms)	Allows option to set buffer mode to Size in KB or Delay ms
Buffer Size (KB)	1 – 4000 KB	This setting determines how much data is received before the MRD 4400 starts decoding. Increasing this value will allow the MRD 4400 is receive streams on networks with high network jitter. Increasing this value also increases the latency of the MRD 4400.
Buffer Delay (ms)	1 – 4000 ms	The buffer delay setting allows the buffer size to be set by delay time. The Buffer delay time will be determined by the input data rate.
Statistics Reset Mode	Manual Auto	Statistics can be viewed by hitting the + symbol next to the MPEG/IP option card on the main window. Selecting Auto will reset the statistics on a chosen interval. When the reset occurs, statistical information for that period will be logged. Selecting Manual will only clear the statistics by hitting the refresh button.

Reset Interval (min) 5-65535 Interval in which the Auto option will reset and log the statistics displayed on the main window

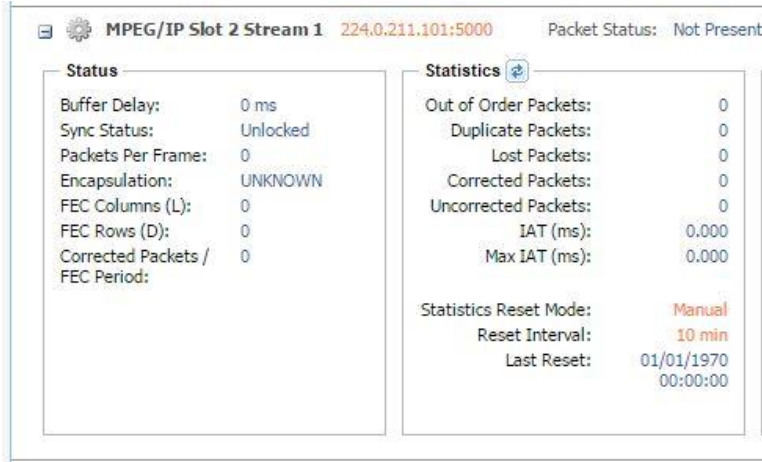

IP statistics menu

4.2.4 Configuring DVB-S/S2/S2X Input

If the DVB-S/S2/S2X input card was selected as a factory installed option, the following menus and options will be available for configuration. This menu allows the user to configure the DVB-S/S2/S2X inputs. The input card is equipped with dual demodulators and four ports (labeled A, B, C and D). This configuration allows the card to receive two signals simultaneously for fast switching between primary and backup inputs. The menu for both demodulators have the same settings. The input card will automatically detect modulation and symbol rate during signal acquisition. LNB Power configuration for this input card is done in the Admin tab.

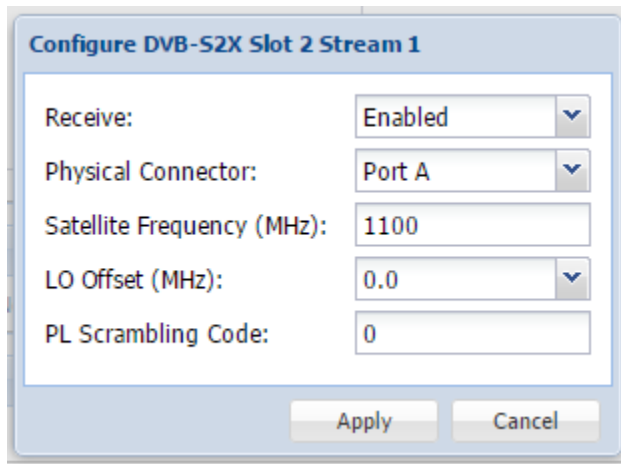

Receive Enabled/Disabled This setting allows the user to enable or disable this input stream.

Physical Connector	Port A Port B Port C Port D	This setting allows the user to select which physical RF connector will be used to receive the stream.
Satellite Frequency	C-Band: 4GHz – 8GHz Ku Band: 11.2Ghz – 14.5Ghz L-Band: 950MHz – 2150MHz Dependent on LO Offset	If LO Offset is set to 0 then L-Band frequency is entered into the Satellite Frequency dialog box. If LO Offset to set to a pre-defined option then enter C-band or Ku-Band frequency.
LO Offset	5150 9750 10600 10750 11250	The offset in MHz that the local oscillator is operating.
PL Scrambling Code	0 – 262141	The MRD has the ability to receive satellite signals scrambled using PL Scrambling. In order to receive the stream, enter the value of the incoming signals PL Scrambling code.

4.2.5 Configuring DVB-S/S2 Input

If the DVB-S/S2 Input card was selected as a factory installed option, the following menus and options will be available for configuration. This menu allows the user to configure the DVB-S/S2 inputs. Each DVB-S/S2 input card has four ports (labeled A, B, C and D) which only one port can be active at a time. This menu is for setting up the reception of DVB-S/S2 satellite signals. The menu for Port A, B, C and D have the same settings.

Configure DVB-S2 Slot 1 Port B

Port:	Enabled
Mode:	Auto
Satellite Frequency (MHz):	950
Wide Search:	Disabled
LO Offset (MHz):	0.0
Symbol Rate Mode:	Manual
Symbol Rate (MSps):	1
PL Scrambling Code:	0
LNB Power:	Off
22kHz Tone:	Disabled
Multistream State:	Disabled
ISI:	0

Apply Cancel

Setting	Range	Description
Port	Enabled Disabled	This setting allows the user to enable or disable this reception port.
Mode	DVB-S DVB-S2 Auto	This setting allows the user to choose between <i>DVB-S</i> or <i>DVB-S2</i> modulation schemes. Setting to Auto will have the unit automatically detect whether the input is DVB-S or DVB-S2.
Satellite Frequency	C-Band: 4GHz – 8GHz Ku Band: 11.2Ghz – 14.5Ghz L-Band: 950MHz – 2150MHz Dependent on LO Offset	If LO Offset is set to 0 then L-Band frequency is entered into the Satellite Frequency dialog box. If LO Offset to set to a pre-defined option then enter C-band or Ku-Band frequency.
Wide Search	Enable Disable	When Enabled the search range may be extended depending on the symbol rate. See appendix C for more information.
LO Offset	5150 9750	The offset in MHz that the local oscillator is operating.

	10600	
	10750	
	11250	
Symbol Rate Mode	Manual Auto	The Manual option allows the user to choose the symbol rate. The Auto option automatically detects the incoming symbol rate. Note: Acquisition time may be longer in auto mode, especially when the symbol rate is below 1MSps or above 55MSps.
Symbol Rate	0 - 60	The symbol rate of incoming satellite signal in MSps. Accurate to one decimal place (kSps). Used when Symbol Rate Mode is set to Manual.
PLS Code	0 – 262141	The MRD 44004400 has the ability to receive satellite signals scrambled using PL Scrambling. In order to receive the stream, enter the value of the incoming signals PL Scrambling code.
LNB Power	Off 13 VDC 14 VDC 18 VDC 19 VDC	The MRD 4400 has the ability to provide the necessary voltage to power an LNB. Select the correct voltage to supply to the LNB.
22kHz Tone	Enabled Disabled	Enabling or disabling the 22khz tone allows the MRD 4400 to trigger the LNB to switch polarities.
Multistream State	Enabled Disabled	The MRD 4400 has the ability to receive multistream satellite signals. If the signal is multistream capable, enable this setting. This option is only available in DVB-S2 Mode. <i>NOTE: This is a licensed feature.</i>
ISI	0-255	This setting is the ISI (Input Stream Identifier) the MRD 4400 uses to filter multistream input. This option is only available if Multistream is licensed and enabled.

4.2.6 Configuring 8VSB/QAM Input

If the 8VSB/QAM Input card was selected as a factory installed option, the following menus and options will be available for configuration. This menu allows the user to configure the 8VSB/QAM input. This menu is for setting up the reception of 8VSB off air signals or QAM cable signals.

Setting	Range	Description
Receive	Enabled Disabled	This setting allows the user to enable or disable this reception port.
Mode	8VSB 64-QAMB 256-QAMB	This setting allows the user to choose between 8VSB or QAM modulation schemes.
Channel Plan	Off Air FCC Cable HRC Cable IRC Cable	If 8 VSB is the selected Mode, the only available option is Off Air. If either 64-QAMB or 256-QAMB is the selected Mode, this setting allows the user to choose which Cable scheme is used.
Channel	Off Air: 2-69 FCC, HRC, or IRC Cable: 2-158	This setting is for the desired channel to be received.
Low RF Level (dBmV)	-34 - +40	This is the Low RF Level threshold when the Low Level Alarm will be triggered in dBmV
Low MER (dB)	0 - 40	This is the Low MER threshold when the Low MER Alarm will be triggered in dB.

4.2.7 Configuring Turbo PSK Input

If the Turbo PSK Input card was selected as a factory installed option, the following menus and options will be available for configuration. This menu allows the user to configure the Turbo PSK input. This menu is for setting up the reception of DVB-S and Turbo PSK satellite signals.

Setting	Range	Description
Receive	Enabled Disabled	This setting allows the user to enable or disable this reception port.
Mode	DVB-S TurboPSK	This setting allows the user to choose between <i>DVB-S</i> or <i>TurboPSK</i> modulation schemes.
Modulation	QPSK 1/2 QPSK 2/3 QPSK 3/4 QPSK 5/6 QPSK 7/8 8PSK 2/3 8PSK 3/4 (2.05) 8PSK 3/4 (2.10) 8PSK 3/4 (2.20) 8PSK 5/6 8PSK 8/9	This setting allows the user to select which modulation parameters are used for the incoming signal and the dropdown list is dependent on the mode that is selected.
LO Offset	5150 9750 10600 10750 11250	The offset in MHz that the local oscillator is operating.

Satellite Frequency	C-Band: 4GHz – 8GHz Ku Band: 11.2Ghz – 14.5Ghz L-Band: 950MHz – 2150MHz Dependent on LO Offset	If LO Offset is set to 0 then L-Band frequency is entered into the Satellite Frequency dialog box. If LO Offset to set to a pre-defined option then enter C-band or Ku-Band frequency.
Symbol Rate	0.256 - 30	The symbol rate of incoming satellite signal in MSps. Accurate to one decimal place (kSps).

Note: Reception may not be possible at rates less than 1MSps

4.2.8 Configuring DVB-T2/C2/ISDB-T Input

If the DVB-T2/C2/ISDB-T Input card was selected as a factory installed option, the following menus and options will be available for configuration. This menu allows the user to configure a DVB-T/T2/C/C2 or ISDB-T input.

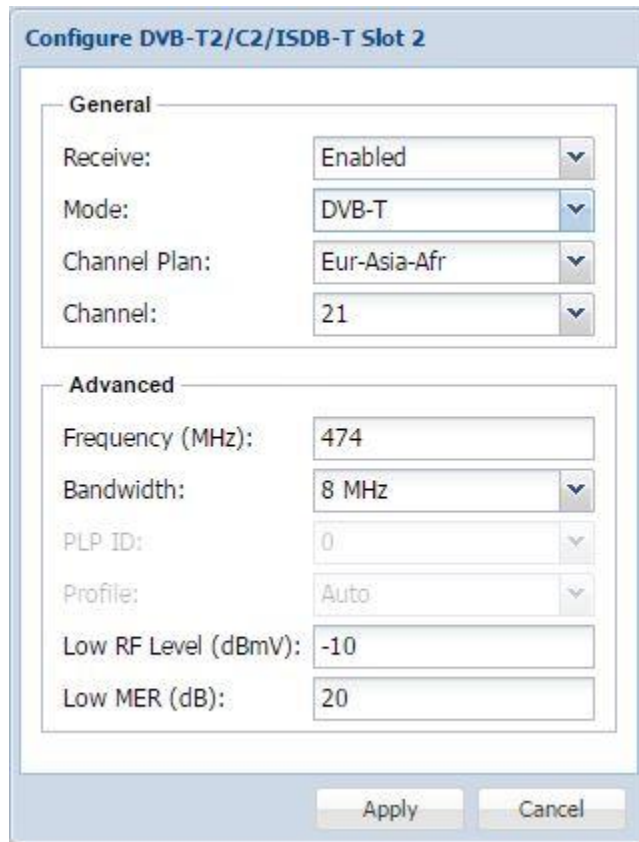



Setting	Range	Description
Recieve	Enabled Disabled	This setting allows the user to enable or disable this reception port.
Mode	DVB-T DVB-T2 DVB-C DVB-C2 ISDB-T	This setting allows the user to choose between <i>DVB-T/T2/C/C2</i> or <i>ISDB-T</i> modulation schemes.
Channel Plan	Australia Eur-Asia-Afr Ireland New Zealand Taiwan South Africa South America United Kingdom European Cable Japan Philippines	This setting allows the user to select which channel plan they would like to use. Channel Plan options are tied to which modulation mode is selected.
Channel		Select a channel from the channels available in the dropdown. The list of available channels will be based on which channel plan is selected
Frequency (MHz)	42-1002	Selecting a channel from the channel dropdown will populate this field automatically based on the user selected channel. A user can manually select a frequency if desired
Bandwidth	1.7 MHz 5 MHz 6 MHz 7 MHz 8 MHz	Selecting a channel from the channel dropdown will populate this field automatically based on the user selected channel plan. A user can manually select channel bandwidth if desired.
PLP ID		Unique PLP ID used to select a particular stream within the DVB-T2 or DVB-C2 input signal

Profile	Auto Base Lite	Select the DVB-T2 profile to use
Low RF Level (dBmV)	-34 - +40	This is the Low RF Level threshold when the <i>Low Level</i> Alarm will be triggered in dBmV
Low MER (dB)	0 - 40	This is the Low MER threshold when the <i>Low MER</i> Alarm will be triggered in dB.

4.2.9 Configuring DVB-CI Descrambling

This section will describe how to configure DVB-CI descrambling in the MRD 4400. First, the user will need to configure the CAM slots and descrambling mode. Once this is complete the user can configure which services or PIDs to descramble.

4.2.9.1 Configuring DVB-CI Slots

This menu allows the user configure the DVB-CI slots in the MRD 4400. The MRD 4400 has two DVB-CI slots, a top and bottom, where CAM Modules can be inserted. Both slots are individually configurable using the Bottom Slot and Top Slot tabs. CAM Modules can be reset manually using the  button. The  button opens the MMI (Man Machine Interface) for the CAM in the respective slot. MMI support is dependent on what is supported by the CAM

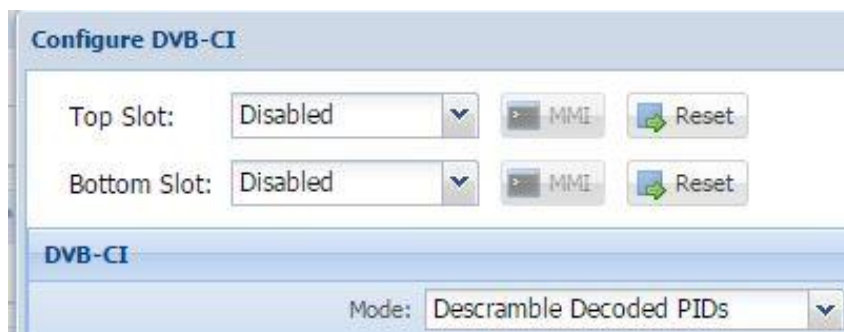





Setting	Range	Description
Mode	Descramble Decoded PIDs Descramble Selected PIDs Descramble Selected Services	<i>Decoded PIDs</i> sets the MRD to descramble only the PIDs of the service that is currently set to decode. If the PIDs change in the incoming stream the MRD will adapt to these changes, provided that Service Selection is set to "Service Lock" (Refer to Section 4.2.11). <i>Selected PIDs</i> sets to the MRD to descramble PIDs set in the Descramble Services window (Refer to

Section 4.2.9.2). If the PIDs change in the incoming stream the MRD will not adapt to these changes and will not be able to descramble. . Selected Services sets the MRD to descramble Services set in the Descramble Services window Refer to Section 4.2.9.2). If the Services change in the incoming stream the MRD will not be able to descramble.

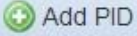
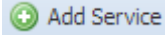
Top Slot	Enabled	This setting allows the user to enable or disable the DVB-CI slot.
Bottom Slot	Disabled	

4.2.9.2 Configuring Service Descrambling

This menu allows the user to select the services the MRD 4400 will descramble using the CAM Modules and Smart Cards inserted into the DVB-CI slots. See Section 4.2.9.1 to configure these slots. These options are applicable only if the Mode in the DVB-CI settings is set to Selected PIDs or Selected Services (Refer to Section 4.2.9.1). The drag and drop method can be used to drag services from the right column to the left column. The drop down menu next to each selected service allows the user to choose either the bottom or top slot to descramble the service. If in Selected PIDs mode PIDs to descramble can be added manually by clicking  button. If in Selected Services mode, Services to descramble can be added manually by clicking the  button. The icons next to each service indicate whether the service is scrambled or not scrambled. Scrambled services will show the  icon next to them while services that are not scrambled will show the  icon. Clicking the  button forces the MRD 4400 to rescan the transport stream for changes.

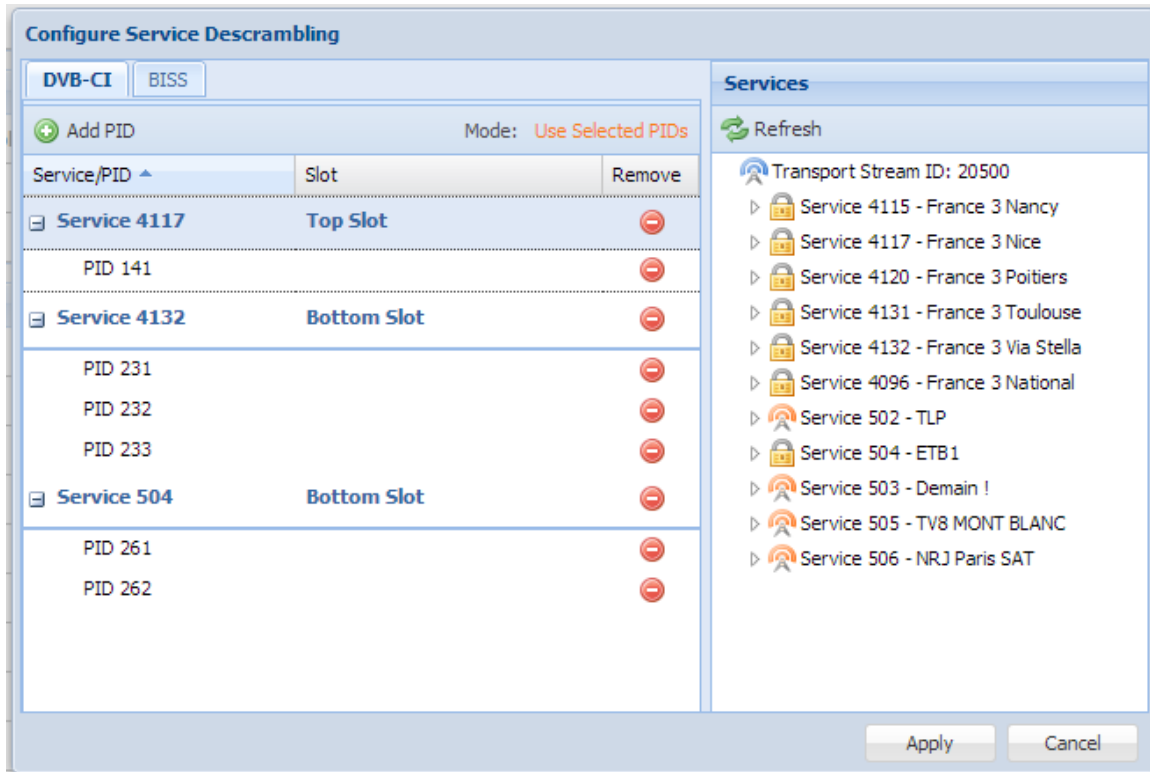

DVB-CI Service Descrambling Menu

4.2.10 Configuring BISS Descrambling

This section will describe how to configure BISS descrambling in the MRD 4400. There are two types of BISS descrambling.

In “Descramble All PIDs” or “Descramble Decoded PIDs” mode, the user simply configures a BISS key set and selects it from the drop down.

For streams with multiple, per-service keys the user must first configure the key sets, and then assign them to services.

4.2.10.1 Configuring BISS Keys

This menu allows the user to configure BISS descrambling. 12 unique BISS keys can be entered. If the BISS mode is set to Mode E a  icon will appear next to Mode E Injected ID. This icon allows the user to unlock and modify the Injected ID.

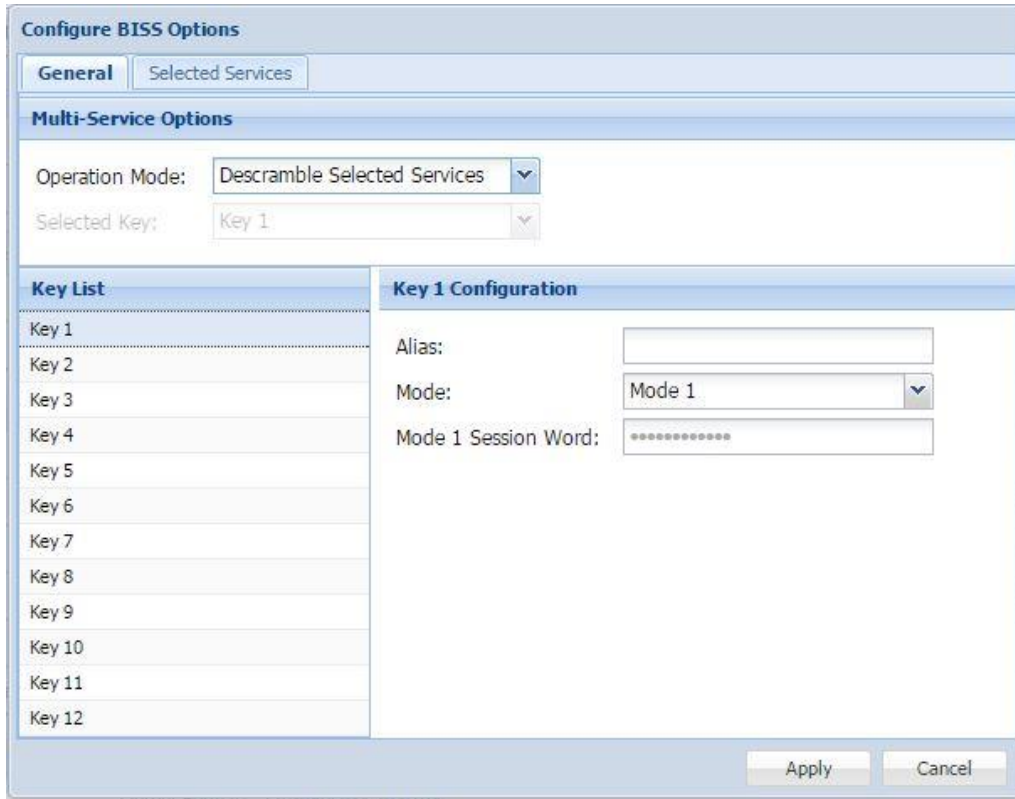



BISS Menu

Setting	Range	Description
Operation Mode	Disabled Descramble Decoded PIDs Descramble Selected Services Descramble All PIDs	Descramble Decoded PID's will descramble the pids that are currently assigned to be decoded by the MRD 4400. Descramble Selected Services will allow the user to select service(s) to be descrambled on the Selected Services tab. Descramble All PIDs will apply the selected key to the entire transport stream.
Selected Key	Key 1-12	Select a key to configure.
Alias	16 characters	Set an Alias for the selected key.
Mode	Mode 1 Mode E	This setting sets the Mode of the BISS key that has scrambled the transport stream.
Mode 1 Session Word	N/A	If Mode 1 is selected the user enters the BISS session word here.
Mode E Session Word	N/A	If Mode E is selected the user enters the BISS session word here.

Mode E Injected ID	N/A	If Mode E is selected the user enters the BISS injected ID here.
---------------------------	-----	------------------------------------------------------------------

4.2.10.2 Configuring Per-Service Descrambling

This menu allows the user to select the services the MRD 4400 will descramble using the BISS keys configured in Section 4.2.10.1. These options are applicable only if Operation Mode in the BISS settings is set to Descramble Selected Services (Refer to Section 4.2.10.1). The drag and drop method can be used to drag services from the right column to the left column. The BISS key to descramble services can be selected using the drop down menu next to each service. Services can be added manually by clicking  Add Service button. Clicking the  Refresh button forces the MRD 4400 to rescan the transport stream for changes.

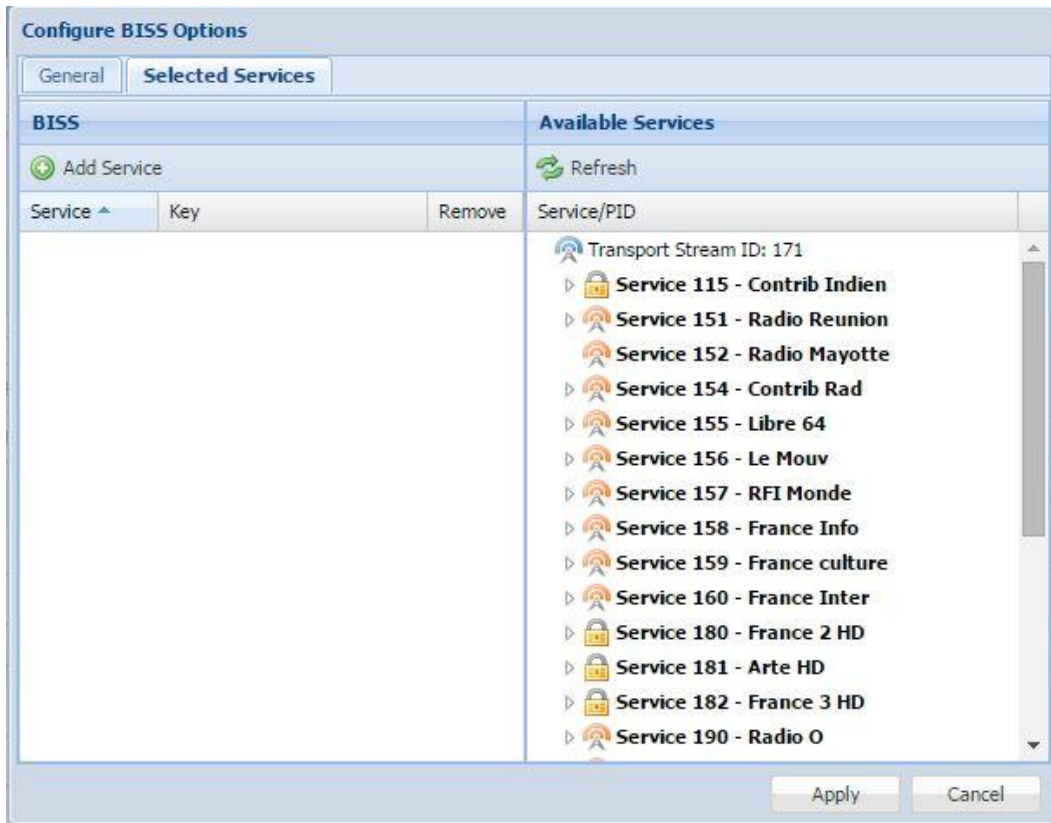

BISS Service Descrambling Menu

4.2.11 Configuring Service Selection

This menu allows the user to configure the PIDs or Service the MRD 4400 will decode. Depending on the Selection Mode that is set, the menu will change to reflect the applicable settings.

Service Lock

In Service Lock mode the MRD is set to decode a specified service number or service name. If the PIDs within the service change at any time, the MRD will continue to decode the service. The drag and drop method can be used to populate the Service Name or Service Number dialog boxes.

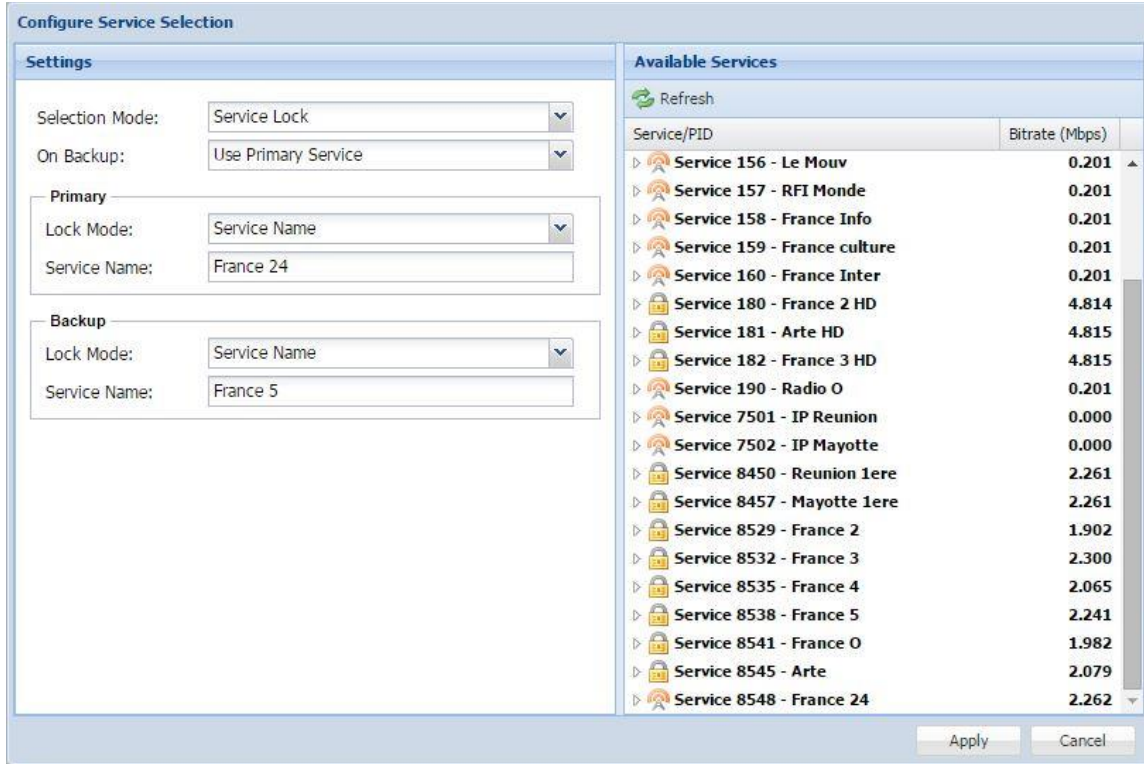

Service Lock Selection Menu

Setting	Range	Description
Selection Mode	Service Lock PID Lock Auto Seek	Setting to <i>Service Lock</i> sets the unit to decode any PIDs associated with a service number or service name. Setting to <i>PID Lock</i> sets the unit to decode only the PIDs specified in the PID Lock Configuration matrix. <i>Auto Seek</i> mode will tune the unit to the first service listed in the PAT if a transport stream is present.
On Backup	Use Primary Service Use Backup Service	Sets the service the MRD 4400 will tune to in case of an input failover. If <i>Use Primary Service</i> is selected the MRD 4400 will tune to the service name specified in the Primary section. If <i>Use Backup Service</i> is selected the service name specified in the Backup section will be tuned. How the MRD 4400 fails over inputs is configured in Section 4.2.1
Lock Mode	Service Name	If set to <i>Service Name</i> the MRD will decode only services matching the name specified

Service Number (SDT in DVB or TVCT in ATSC tables must be present in this mode). If set to *Service Number* the MRD will decode only services matching the number specified.

Note: S302M Audio Type is now auto detected by the MRD 4400

PID Lock Mode

In PID Lock mode the MRD will only decode the PIDs specified by the user in the PID Lock Configuration matrix. The drag and drop method can be used to auto-populate the cells in the matrix. Stream types can be manually defined under the Primary Type and Backup Type columns. Individual cells under Primary and Backup columns can be selected and PIDs can be typed in manually.

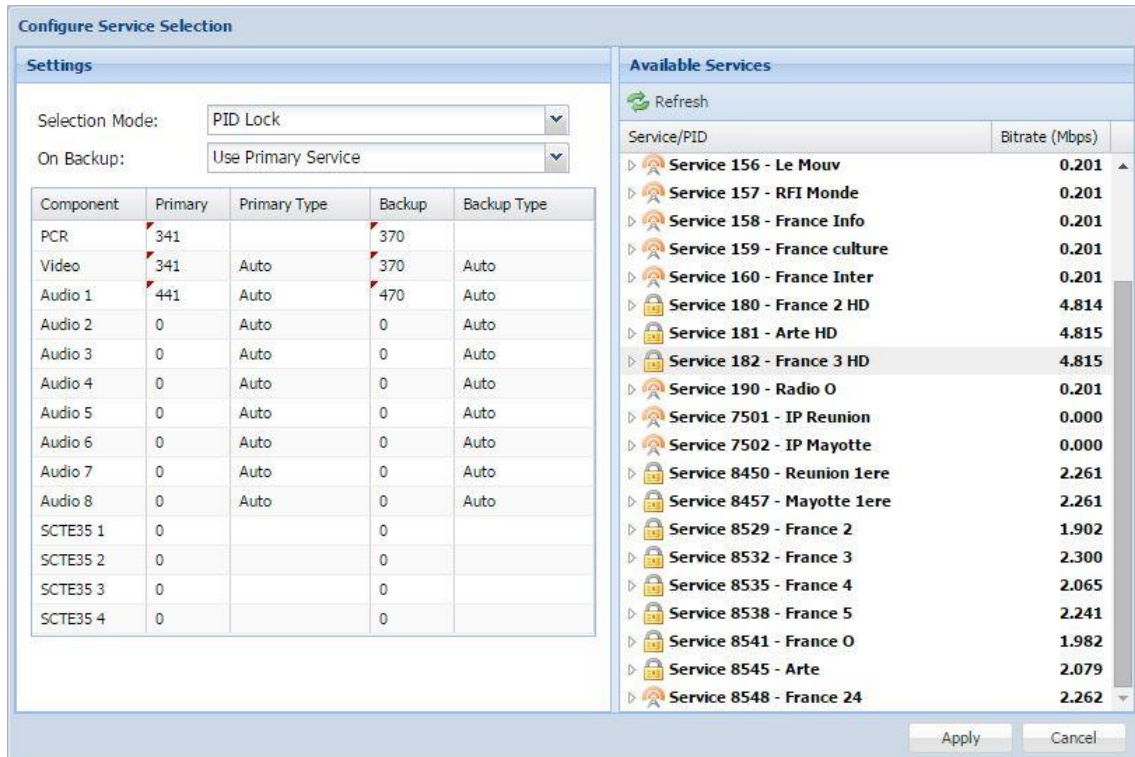

PID Lock Selection Menu

Setting	Range	Description
On Backup	Use Primary PIDs Use Backup PIDs	Sets the PIDs the MRD 4400 will tune to in case of an input failover. If <i>Use Primary PIDs</i> is selected the MRD 4400 will tune to the PIDs specified in the Primary PID column. If <i>Use Backup PIDs</i> is selected the service name specified in the Backup PID column will be tuned. How the MRD 4400 fails over inputs is configured in Section 4.2.1.

Auto Seek Mode

In Auto Seek mode the MRD will decode first service listed in the PAT. All PIDs will automatically be assigned and decoded. No other configurations are available in this mode. This mode should only be used to verify the MRD is receiving a valid signal and it able to decode. This mode is not recommended for a professional environment.

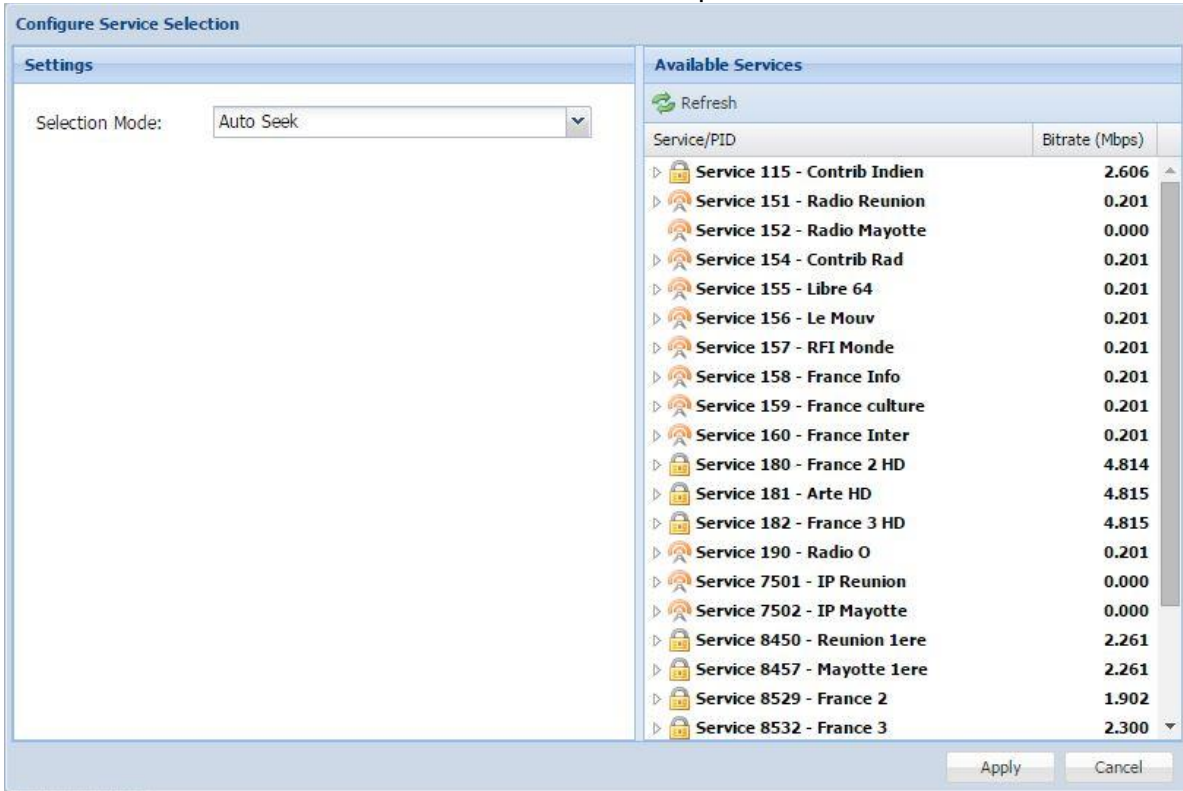

Auto Seek Menu

4.2.12 Configuring Video Services

The menu allows the user to configure the SDI, Digital Video and Composite output formats of the MRD 4400. Please note that the composite video output is only active if the output video format is SD. Overlays and image insertion are configured in this menu as well. This menu will be labeled as Primary Video if a Simultaneous SD Video Card is an installed option.

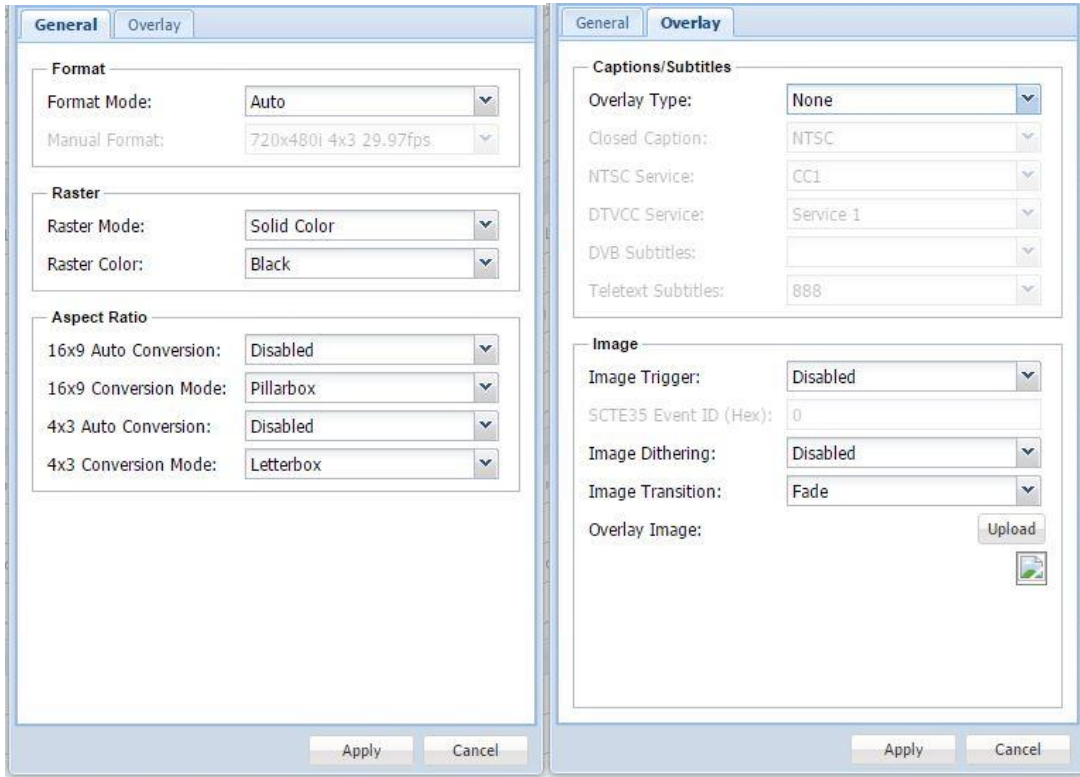

General and Overlay Options

Setting	Range	Description
Format Mode	Auto Manual	Setting to <i>Auto</i> the MRD 4400 will output video to match the incoming native video format. Setting to <i>Manual</i> the user can define the video format the MRD 4400 will output.
Manual Format	Refer to Appendix C for supported formats.	This setting is the video format the MRD 4400 will output.
Raster Mode	Solid Color Last Frame	If no input is present the MRD 4400 will output either the last frame present or raster

Raster Color	Black, White, Yellow, Cyan, Magenta, Red, Blue, Green, Gray	If no input is present the MRD 4400 will output raster. This is the color of the video the MRD will output.
4x3 Output Aspect Ratio Auto Conversion	Disabled AFD	If 4x3 Auto Conversion is set to <i>Disabled</i> the MRD 4400 uses the 4x3 Conversion Mode setting to format video. If 4x3 Auto Conversion is set to <i>AFD</i> the MRD 4400 will apply the conversion defined by the AFD code in the incoming stream. If 4x3 Auto Conversion is set to <i>AFD</i> , but the AFD code is not present or invalid in the incoming stream the 4x3 Conversion Mode setting will be used.
4x3 Output Aspect Ratio Conversion Mode	Center-Cut Letterbox Anamorphic	<i>Center-Cut</i> cuts off the top and bottom of the video. <i>Letterbox</i> adds bars at the top and bottom of the video. <i>Letterbox</i> adds bars at the top and bottom of the video. <i>Pillarbox</i> adds bars at the left and right of the video. <i>Anamorphic</i> stretches the video height and width to match the format mode.
16x9 Output Aspect Ratio Auto Conversion	Disabled AFD	If 16x9 Auto Conversion is set to <i>Disabled</i> the MRD 4400 uses the 16x9 Conversion Mode setting to format video. If 16x9 Auto Conversion is set to <i>AFD</i> the MRD 4400 will apply the conversion defined by the AFD code in the incoming stream. If 16x9 Auto Conversion is set to <i>AFD</i> , but the AFD code is not present or invalid in the incoming stream the 16x9 Conversion Mode setting will be used.
16x9 Output Aspect Ratio Conversion Mode	Center-Cut Pillarbox Anamorphic	<i>Center-Cut</i> cuts off the sides of the video. <i>Pillarbox</i> adds bars at the left and right of the video. <i>Anamorphic</i> stretches the video height and width to match the format mode.
Overlay Type	None Closed Captions DVB Subtitles Teletext Subtitles	<i>Closed Captions</i> overlays burns closed captioning in the video output. <i>DVB Subtitles</i> burns subtitles in video output. <i>Teletext Subtitles</i> burns subtitles in the video output. <i>None</i> disables overlays completely.
Closed Caption	NTSC DTVCC	Sets the type of closed captions that will be in the overlay.
NTSC Service	CC1 – CC4	Sets the NTSC closed caption service that will be displayed in the overlay. This setting is only available if the Closed Caption option is set to NTSC.
DTVCC Service	Service 1-6	Sets the DTVCC closed caption service that will be displayed in the overlay. This setting

		is only available if the Closed Caption option is set to DTVCC.
DVB Subtitles	Language Codes	If DVB Subtitles overlays are enabled this setting choosing the language which the subtitles are displayed. Only the languages present in the stream are given.
Teletext Subtitles	3 Hexidecimal Characters	If Teletext Subtitles overlays are enabled this setting choosing the page (language) of which subtitles are displayed. Only the pages present in the stream are given.
Image Trigger	Disabled SCTE 35 Decode Failure Always Active	This setting will enable or disable the image overlay in the video output. The SCTE 35 option will insert based on an event ID. The decode failure option will overlay the image if the video not decoding error is raised. Always active will always overlay the image in the video output.
SCTE35 Event ID		Specify the SCTE35 Event ID that will cause the image overlay to trigger.
Image Dithering	Enabled Disabled	Enable or Disable dithering of the uploaded image
Image Transition	Fade Cut	Specify if the image should fade in and out or cut in and out when using SCTE 35 or Decode Failure options

4.2.13 Configuring Secondary Video Services

This menu, if applicable, allows the user to configure the simultaneous SDI, and the second Composite output of the MRD 4400. Please note the simultaneous SDI output is limited to SD only. Also note the simultaneous SDI and simultaneous Composite outputs will output the same selected service as the primary video output.

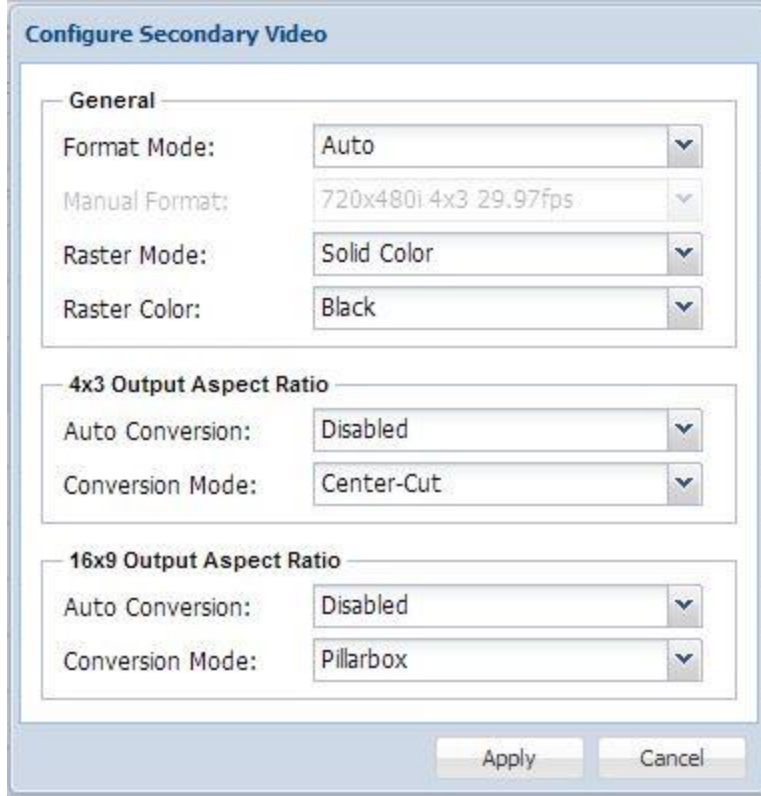

Setting	Range	Description
Format Mode	Auto Manual	Setting to <i>Auto</i> the MRD 4400 will output video in an SD format based on the incoming native video format. Setting to <i>Manual</i> the user can define the SD video format the MRD 4400 will output.
Manual Format	720x576i (4x3 or 16x9) @ 25Hz 720x480i (4x3 or 16x9) @ 29.97Hz	This setting is the video format the MRD 4400 will output.
Raster Mode	Solid Color Last Frame	If no input is present the MRD 4400 will output either the last frame present or raster.
Raster Color	Black, White, Yellow, Cyan, Magenta, Red, Blue, Green, Gray	If no input is present and solid color option is chosen the MRD 4400 will output raster. This is the color of the video the MRD will output.
4x3 Output Aspect Ratio Auto Conversion	Disabled	If 4x3 Auto Conversion is set to <i>Disabled</i> the MRD 4400 uses the 4x3 Conversion

	AFD	Mode setting to format video. If 4x3 Auto Conversion is set to <i>AFD</i> the MRD 4400 will apply the conversion defined by the AFD code in the incoming stream. If 4x3 Auto Conversion is set to <i>AFD</i> , but the AFD code is not present or invalid in the incoming stream the 4x3 Conversion Mode setting will be used.
4x3 Output Aspect Ratio Conversion Mode	Center-Cut	<i>Center-Cut</i> cuts off top and bottom of the video. <i>Letterbox</i> adds bars at the top and bottom of the video. <i>Anamorphic</i> stretches the video height and width to match the format mode.
	Letterbox	
	Anamorphic	
16x9 Output Aspect Ratio Auto Conversion	Disabled	If 16x9 Auto Conversion is set to <i>Disabled</i> the MRD 4400 uses the 16x9 Conversion Mode setting to format video. If 16x9 Auto Conversion is set to <i>AFD</i> the MRD 4400 will apply the conversion defined by the AFD code in the incoming stream. If 16x9 Auto Conversion is set to <i>AFD</i> , but the AFD code is not present or invalid in the incoming stream the 16x9 Conversion Mode setting will be used.
	AFD	
16x9 Output Aspect Ratio Conversion Mode	Center-Cut	<i>Center-Cut</i> cuts off the sides of the video. <i>Pillarbox</i> adds bars at the left and right of the video. <i>Anamorphic</i> stretches the video height and width to match the format mode.
	Pillarbox	
	Anamorphic	

4.2.14 Configuring Audio

This menu allows the user to configure the audio downmix settings or select a pair of discrete audio channels (if the 5.1 discrete audio license is present). Two audio presets are available: Transmission and Monitor. These presets can be applied by clicking the **Presets** button. The menus for Audio 1 through Audio 4 all contain the same settings.

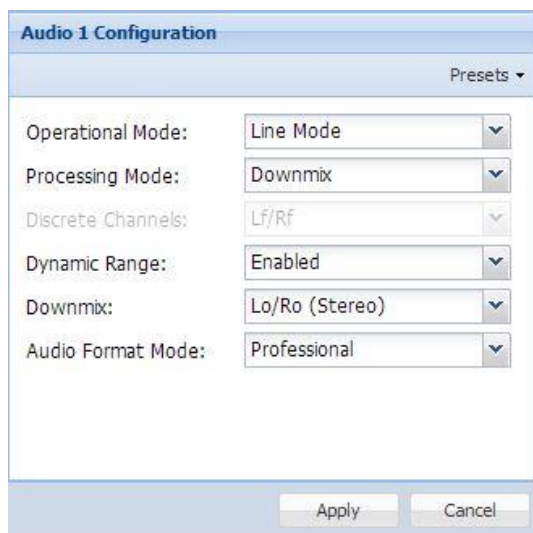

Setting	Range	Description
Operational Mode	Line Mode	Refer to Appendix E for explanation.
	RF Mode	
	Custom 1	
	Custom 0	
Processing Mode	Downmix	Refer to Appendix E for explanation.
	Discrete	Refer to Appendix F for explanation
Discrete Channels	Lf/Rf	Selectable Pairs of Discrete Channels(Refer to Appendix F)
	C/LFE	
	Ls/Rs	
	Ch1/Ch2	
	Ch3/Ch4	
	Ch5/Ch6	
	Ch7/Ch8	
Dynamic Range	Enabled	Refer to Appendix E for explanation.
	Disabled	
Downmix	Lo/Ro (Stereo)	When the audio is downmixed in the MRD 4400 two audio channels are created. The channels can be configured using the settings available in the drop down menu. (Refer to Appendix E)
	Lt/Rt (Dolby Surround)	
	Lt/Rt (Auto)	
	Dual Mono	
	Dual Left	
	Dual Right	

Dolby Format Mode	Consumer	This option selects the Dolby Digital format mode. (Refer to Appendix E)
	Professional	

4.2.15 Configuring Genlock

If the Genlock Reference option was selected as a factory installed option, the following menus and options will be available for configuration. This menu allows the user to configure the genlock reference used by the MRD 4400. The MRD 4400 can be configured to use an external user provided reference or disabled completely.

Setting	Range	Description
Reference Source	Disabled External	Setting to <i>Disabled</i> will synchronize video output to the PCR carried in the transport stream. Setting to <i>External</i> uses the user provided external genlock reference.
SD Vertical (Lines)	-312 - 312	Plus or minus half of the number of lines in the genlock reference for SD formats.
SD Horizontal (Pixels)	-431 - 432	Plus or minus half of the number of pixels in the genlock reference SD formats.
Subcarrier (Degrees)	-180 - 180	Plus or minus 180 degrees of the color subcarrier.

HD Vertical (Lines)	-562 - 562	Plus or minus half of the number of lines in the genlock reference for HD formats.
HD Horizontal (Pixels)	-1374 - 1375	Plus or minus half of the number of pixels in the genlock reference for HD formats.

Note: The Genlock reference connector if enabled requires external termination.

4.2.16 SCTE35

If the SCTE35 license is enabled, the following menus and options will be available for configuration. The SCTE35 to SCTE104 and SCTE35 to Relay options are used in an application where the MRD 4400 is receiving a transport stream with SCTE35 DPI splice messages.

In an SCTE35 to 104 configuration, the MRD extracts SCTE 35 messages from the transport stream and converts them to SCTE104 messages, and embeds them as VANC packets on the SDI output.

In the SCTE35 to relay configuration the unit will trigger a relay based on SCTE35 DPI splice message and user configurations for the relays.

The SCTE 35 insertion option contains configuration settings for manually triggered or SNMP triggered SCTE 35 DPI splice messages.

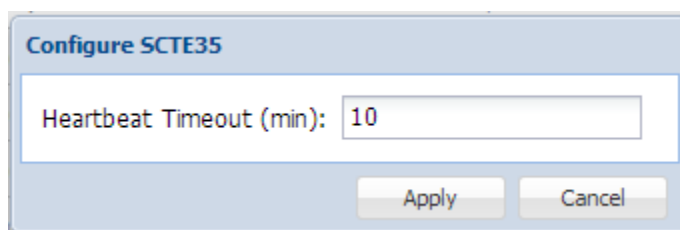

Setting	Range	Description
Heartbeat Timeout (min)	1-60	Setting this value will determine the time in minutes between SCTE35 messages before the MRD 4400 will report an error

General	Relays
Select Trigger	Trigger 1 Configuration
Trigger 1	Relay Triggering: Enabled
Trigger 2	Relay Output: Relay 1
Trigger 3	Event ID Filter: Pass All
	Event ID (Hex): 0
	Event Source (Hex): 0
	Offset (ms): 0
	Relay Mode: Pulse
	Pulse Event: Out of Network
	Pulse Duration (ms): 100
	Latch Timeout (sec): 40

Setting	Range	Description
Relay Triggering	Enabled Disabled	Enable or Disable selected Trigger
Relay Output	Relay 1 Relay 2 Relay 3	Select which Relay the configured trigger will use. See appendix D for relay pinout.
Event ID Filter	Pass All Pass Event ID Pass Event Source	Selects whether all Events will trigger the relay, or only those with a certain Event ID or Source
Event ID (Hex)	0-FFFFFFFF	Used in “Pass Event ID” mode to filter which SCTE 35 messages that will trigger the relay
Event Source (Hex)	0-FFFFFFFF	Used in “Pass Event Source” mode to filter which SCTE 35 messages that will trigger the relay
Offset (ms)	-4000ms to 4000ms	Specify an offset for the Trigger
Relay Mode	Pulse Latch	Specify a mode for the relay. In pulse mode the relay will fire once on either OON or RTN. In latch mode the relay will remain energized for the entire break duration

Pulse Event	Out of Network Return to Network	Select which SCTE 35 splice_insert message triggers the relay
Pulse Duration (ms)	10-1000	Select a duration for the pulse
Latch Timeout (ms)	1-300	Specify a duration for latch mode. Note: Receiving a Return to Network message will override the latch timeout.

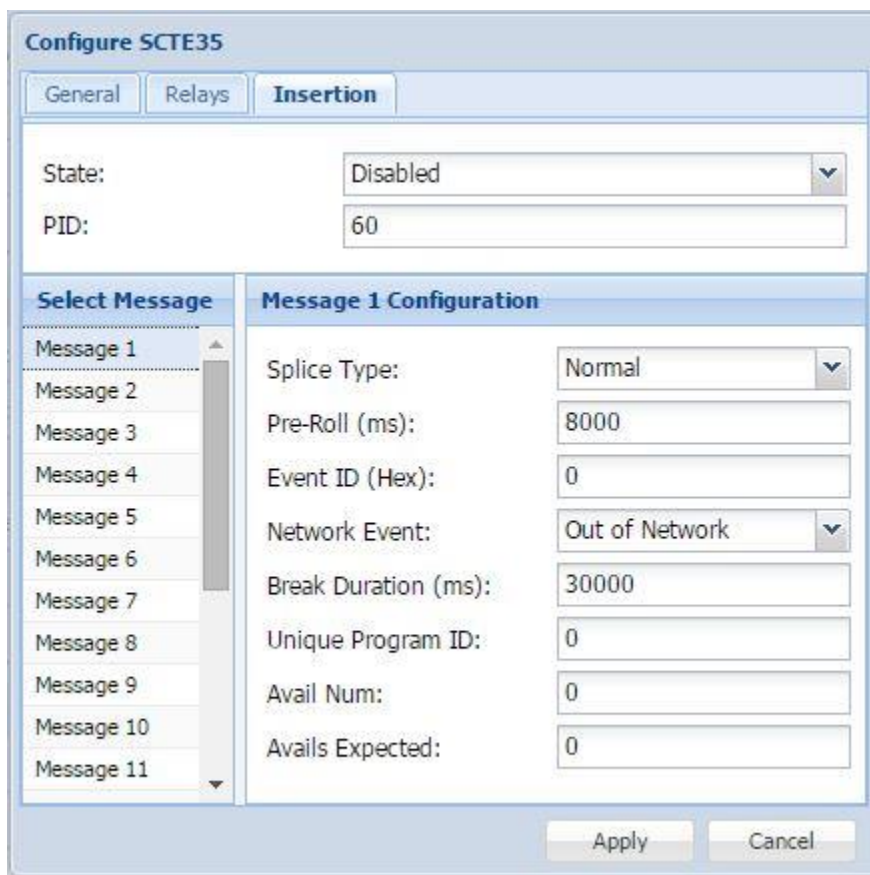

Setting	Range	Description
State	Enabled Disabled	Enable or Disable SCTE 35 message Insertion
PID	0-8191	PID on which the inserted SCTE 35 messages will be inserted
Splice Type	Normal Immediate	Selects whether the SCTE 35 message will be of the “splice immediate” type (which can trigger an instantaneous switch downstream) or the normal type which uses

		a PTS-based preroll value to time the insertion.
Pre-Roll (ms)	0-20000	Configured offset prior to splice point
Event ID (Hex)	0-FFFFFFF	Unique Event ID for the the SCTE 35 message
Network Event	Out of Network Return to Network	Select which network transition signal is used for the SCTE 35 message
Break Duration (ms)	0-95443717	Duration in ms of the Out of Network Break
Unique Program ID	0-65535	Unique program identification within a service
Avail Num	0-255	Authentication for a specific avail in the Unique Program ID
Avails Expected	0-255	Number of Avails expected in the current viewing event

Messages can be manually inserted by clicking the green arrow that is shown when the SCTE 35 section is expanded as shown below. In a typical operational scenario, the splice insertion will be automated and triggered using the SNMP MIB.

SCTE35/ESAM

SCTE35 General Configuration

Heartbeat Timeout (min): 10

Trigger 1 Configuration

Relay Triggering: Disabled
Relay Output: Relay 1
Event Filter: Pass All
Event ID: 0x0
Event Source: 0x0
Offset: 0 ms
Relay Mode: Pulse
Pulse Event: Out of Network
Pulse Duration: 100 ms
Latch Timeout: 40 sec

Trigger 2 Configuration

Relay Triggering: Disabled
Relay Output: Relay 1
Event Filter: Pass All
Event ID: 0x0
Event Source: 0x0
Offset: 0 ms
Relay Mode: Pulse
Pulse Event: Out of Network
Pulse Duration: 100 ms
Latch Timeout: 40 sec

Trigger 3 Configuration

Relay Triggering: Disabled
Relay Output: Relay 1
Event Filter: Pass All
Event ID: 0x0
Event Source: 0x0
Offset: 0 ms
Relay Mode: Pulse
Pulse Event: Out of Network
Pulse Duration: 100 ms
Latch Timeout: 40 sec

SCTE35 Insertion Configuration

State: Disabled
PID: 60

Message	Splice Type	Pre-Roll	Event ID	Event	Break Duration	Program ID	Avail Num	Avails Expected	Insert Message
Message 1	Normal	8000 ms	0x0	OON	30000 ms	0	0	0	➡
Message 2	Normal	8000 ms	0x0	OON	30000 ms	0	0	0	➡
Message 3	Normal	8000 ms	0x0	OON	30000 ms	0	0	0	➡
Message 4	Normal	8000 ms	0x0	OON	30000 ms	0	0	0	➡

4.2.17 ESAM

If the ESAM license is enabled, the following menu and options will be available for configuration. The MRD interfaces with a Placement Opportunity Information Service (POIS) using the CableLabs ESAM (Real-time Event Signaling and Management) standard. When the ESAM feature is configured, each SCTE35 message which is received in the incoming stream is sent to the POIS for processing (via the control

interface). The POIS can request that the MRD replace the message, pass the message with no change, or delete the message.

Asynchronous SCTE 35 message insertion allows the ESAM server to create and insert SCTE 35 messages onto a specified PID in the transport stream.

Setting	Range	Description
ESAM Processing	Enabled Disabled	Enable or Disable ESAM processing
POIS URI	Valid String	Specify the address of the POIS server
POIS Timeout (sec)	1-5	Specify a timeout to receive a response from the POIS
Timeout Behavior	Pass Message Retry POIS Discard Message	Specify a behavior that is used by the MRD if the timeout is reached
Acquisition Point ID	Valid String	Optional reference used by the POIS for processing
Acquisition Signal ID	Valid String	Optional reference used by the POIS for processing

State	Enabled Disabled	Enable or Disable Asynchronous message insertion
Port	0-65535	Port on which the MRD 4400 will listen for SCTE 35 messages from the ESAM server
PID	SCTE 35 Pid present in TS	PID on which the SCTE 35 messages will be inserted in the transport stream

4.2.18 Configuring Ancillary Data Options

This menu allows the user to configure processing options relating to ancillary (ANC/VBI) data generation. Currently it contains options for Source ID and, if the SCTE35 license is enabled, it will also allow the user to configure the filter mode for SCTE104 messages.

Setting	Range	Description
Lookup Mode	Auto Manual	Setting Lookup Mode to auto will use the service information from the active stream service information tables (if source id present). Setting Lookup Mode to manual will allow the user to input a user defined source id.
Manual Source ID	ASCII Characters	User defined Source ID will need to be less than 14 characters
Timeout (sec)	5 – 120 sec	This will define the timeout for automatic extraction.

Filter Mode	Pass All Operations	Setting Pass First Operation will filter SCTE 104 messages with multiple OpIds and only pass the first OpID of that message.
	Pass First Operation	

4.2.19 Configuring SDI Outputs Port 1 & 2

The following menus allow the user to configure the embedded audio and auxiliary data in the SDI video output for port 1 & 2. There are unique settings for SD and HD video. All VANC embedding Line settings contain the values 4 through 19. All HANC embedding Line settings contain the values 5 through 15.

Configure SDI Output Port 1 & 2

SD | HD | Audio

General

Video Loss Mode: Display Raster

VANC

EIA 708-B:	Disabled	Line: 9
ATC:	Disabled	Line: 13
TTX/VPS/WSS (S2031):	Disabled	Line: 5
AMOL/TVG2X/VITC:	Disabled	Line: 5
AFD:	Disabled	Line: 16
RDD11:	Disabled	
SMPTE2038:	Disabled	
VII:	Disabled	Line: 16
Source ID:	Disabled	Line: 10
SCTE104:	Disabled	Line: 12

VBI

TTX:	Disabled
WSS:	Disabled
VPS:	Disabled
AMOL:	Disabled
TVG2X:	Disabled
VITC:	Disabled
L21 Captions:	Disabled

Apply Cancel

SD SDI Output Configuration Menu

General

Setting	Range	Description
Video Loss Mode	Disable SDI Display Raster	Setting to <i>Disable SDI</i> disables the SDI output of the MRD in case of an error state. Setting to <i>Display Raster</i> the MRD will display the raster color selected in Section 4.2.10

VANC Embedding

Setting	Range	Description
EIA 708-B	Enabled Disabled	Enable/Disable EIA 708-B Closed Caption embedding in the VANC. Choose one line between lines 4-19 to embed data.
ATC	Enabled Disabled	Enable/Disable Ancillary Time Code (ATC) embedding in the VANC. Choose one line between lines 4-19 to embed data.
TTX/VPS/WSS (S2031)	Enabled Disabled	Enable/Disable EN301775 VBI waveform data embedding in the VANC. Choose one line between lines 4-19 to embed data.
AMOL/TVG2X/VITC	Enabled Disabled	Enable/Disable SCTE127 VBI waveform data embedding in the VANC. Choose one line between lines 4-19 to embed data.
AFD	Enabled Disabled	Enable/Disable Automatic Format Description (AFD) embedding in the VANC. Choose one line between lines 4-19 to embed data.
RDD11	Enabled Disabled	Enable/Disable Registered Disclosure Document 11 (RDD11) embedding in the VANC.
SMPTE2038	Enabled Disabled	Enable/Disable SMPTE2038 method of embedding data in the VANC.
VII AFD	Enabled Disabled	Enable/Disable AFD in Video Index Data embedding in the VANC. Choose one line between lines 4-19 to embed data.
Source ID	Enabled Disabled	Enable/Disable Source ID embedding in the VANC. Choose one line between lines 4-19 to embed data.

SCTE104	Enabled	Enable/Disable SCTE104 embedding in the VANC. Choose one line between lines 4-19 to embed data.
	Disabled	

SD SDI VBI Embedding

When the MRD 4400 is configured to output SD video the VBI data can be encoded into the vertical blanking as a VBI waveform. The options below allow the user to enable or disable these waveforms.

Setting	Range	Description
TTX	Enabled Disabled	Enable/Disable Teletext embedding in the VBI. The line which Teletext will be embedded is dependent on data in the incoming stream.
WSS	Enabled Disabled	Enable/Disable Widescreen Signaling (WSS) embedding in the VBI. WSS is output on line 23 in the VBI.
VPS	Enabled Disabled	Enable/Disable Video Program System (VPS) embedding in the VBI. VPS is output on line 16 in the VBI.
AMOL	Enabled Disabled	Enable/Disable Automated Measurement of Lineups (AMOL) embedding in the VBI. The line which AMOL will be embedded is dependent on data in the incoming stream.
TVG2X	Enabled Disabled	Enable/Disable TV Guide data embedding in the VBI. The line which TVG2X will be embedded is dependent on data in the incoming stream.
VITC	Enabled Disabled	Enable/Disable Vertical Interval Timecode embedding in the VBI. VITC is sourced from the video elementary stream and is embedded on line 14.
L21 Captions	Enabled Disabled	Enable/Disable Line 21 Closed Caption embedding in the VBI. Closed Captions are output on line 21 in the VBI.

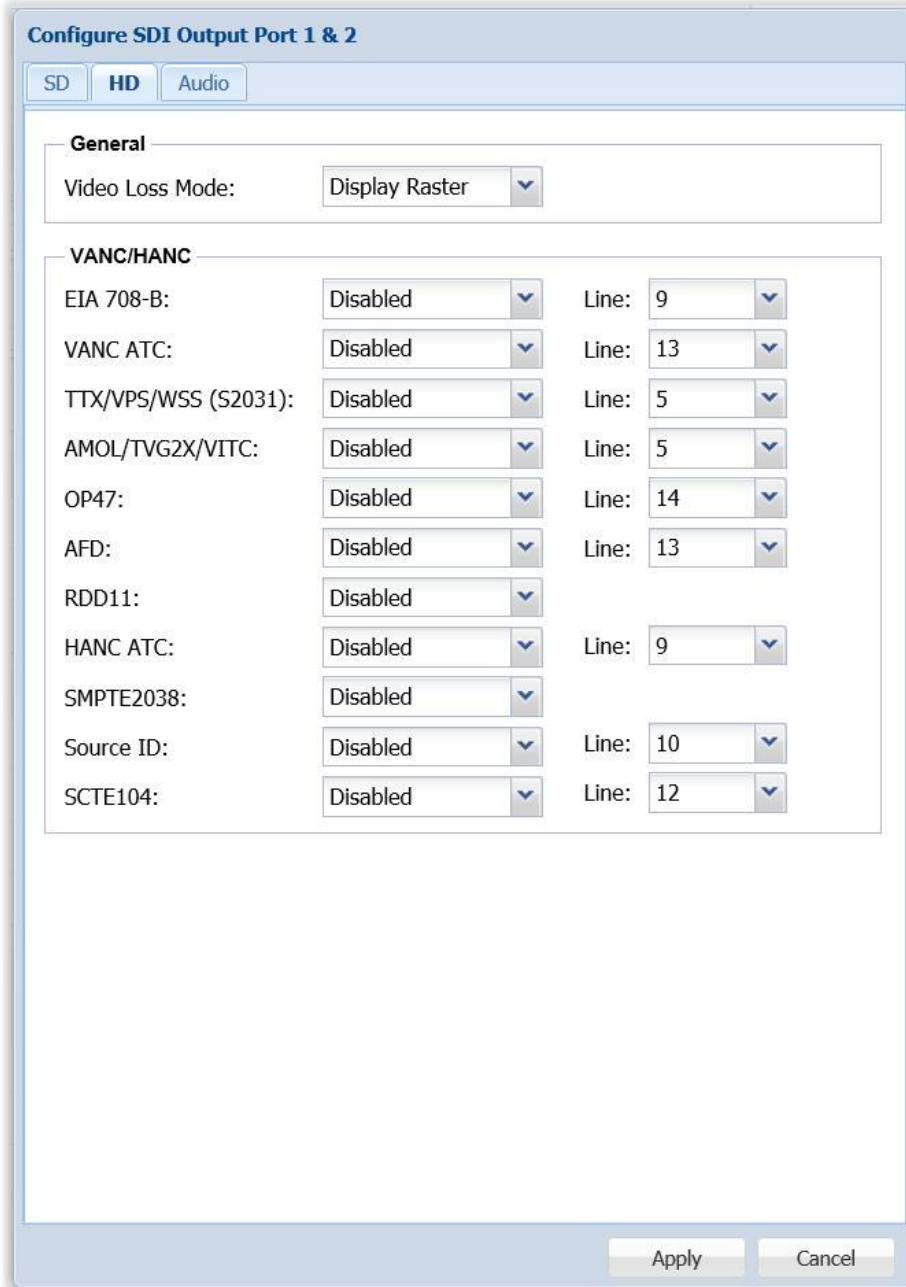

HD SDI Output Configuration Menu

General

Setting	Range	Description
Video Loss Mode	Disable SDI Display Raster	Setting to <i>Disable SDI</i> squelches the SDI output of the MRD in case of an error state. Setting to <i>Display Raster</i> the MRD will display the raster color selected in Section 0.

HD SDI VANC Embedding

Setting	Range	Description
EIA 708-B	Enabled Disabled	Enable/Disable EIA 708-B Closed Caption embedding in the VANC. Choose one line between lines 4-19 to embed data.
VANC ATC	Enabled Disabled	Enable/Disable Ancillary Time Code (ATC) embedding in the VANC. Choose one line between lines 4-19 to embed data.
TTX/VPS/WSS (S2031)	Enabled Disabled	Enable/Disable EN301775 VBI waveform data embedding in the VANC. Choose one line between lines 4-19 to embed data.
AMOL/TVG2X/VITC	Enabled Disabled	Enable/Disable SCTE127 VBI waveform data embedding in the VANC. Choose one line between lines 4-19 to embed data.
OP47	Enabled Disabled	Enable/Disable OP47 Subtitle embedding in the VANC. Choose one line between lines 4-19 to embed data.
AFD	Enabled Disabled	Enable/Disable Automatic Format Description (AFD) embedding in the VANC. Choose one line between lines 4-19 to embed data.
RDD11	Enabled Disabled	Enable/Disable Registered Disclosure Document 11 (RDD11) embedding in the VANC.
HANC ATC	Enabled Disabled	Enable/Disable Ancillary Time Code (ATC) embedding in the HANC. Choose one line between lines 5-15 to embed data.
SMPTE2038	Enabled Disabled	Enable/Disable SMPTE2038 method of embedding data in the VANC.
Source ID	Enabled Disabled	Enable/Disable Source ID embedding in the VANC. Choose one line between lines 4-19 to embed data.
SCTE104	Enabled Disabled	Enable/Disable SCTE104 embedding in the VANC. Choose one line between lines 4-19 to embed data.

4.2.20 Configuring SDI Audio Embedding

This menu allows the user to configure SDI embedded audio settings. The MRD 4400 comes standard with the ability to handle up to two audio services. With additional licensing the MRD 4400 can handle up to four unique audio services. When licensed for four audio services the user will have four audio pairs available to embed audio in the SDI. These two groups consist of four pairs, with two pairs to each group. All audio pairs share the same options.

The screenshot shows a window titled "Configure SDI Output" with three tabs: "SD", "HD", and "Audio". The "Audio" tab is selected. The window is divided into two main sections, "Group 1" and "Group 2". Each group contains two pairs of audio settings, labeled "Pair 1" and "Pair 2". Each pair has a dropdown menu currently set to "Off". At the bottom right of the window are "Apply" and "Cancel" buttons.

SDI Embedded Audio Configuration Menu

Group 1-2	Off	Assigning a <i>PCM</i> audio to a Group Pair will embed the downmixed two channel audio using the settings defined in Section 4.2.13. Assigning <i>Pass-Through</i> to a Group Pair will embed unprocessed compressed audio in the SDI VANC. Selecting Off disables the Group Pair completely.
Pair 1-2	Audio 1-4 PCM	
	Audio 1-4 Pass-through	

4.2.21 Configuring Secondary SDI Outputs

The following menus allow the user to configure the embedded audio and auxiliary data in the secondary, simultaneous SDI video output. All VANC embedding Line settings contain the values 4 through 19.

General

Setting	Range	Description
Video Loss Mode	Disable SDI	Setting to <i>Disable SDI</i> disables the SDI output of the MRD in case of an error state. Setting to <i>Display Raster</i> the MRD will
	Display Raster	

display the raster color selected in Section 0

VANC Embedding

Setting	Range	Description
EIA 708-B	Enabled Disabled	Enable/Disable EIA 708-B Closed Caption embedding in the VANC. Choose one line between lines 4-19 to embed data.
ATC	Enabled Disabled	Enable/Disable Ancillary Time Code (ATC) embedding in the VANC. Choose one line between lines 4-19 to embed data.
TTX/VPS/WSS (S2031)	Enabled Disabled	Enable/Disable EN301775 VBI waveform data embedding in the VANC. Choose one line between lines 4-19 to embed data.
AMOL/TVG2X/VITC	Enabled Disabled	Enable/Disable SCTE127 VBI waveform data embedding in the VANC. Choose one line between lines 4-19 to embed data.
AFD	Enabled Disabled	Enable/Disable Automatic Format Description (AFD) embedding in the VANC. Choose one line between lines 4-19 to embed data.
RDD11	Enabled Disabled	Enable/Disable Registered Disclosure Document 11 (RDD11) embedding in the VANC.
SMPTE2038	Enabled Disabled	Enable/Disable SMPTE2038 method of embedding data in the VANC.
VII AFD	Enabled Disabled	Enable/Disable AFD in Video Index Data embedding in the VANC. Choose one line between lines 4-19 to embed data.
Source ID	Enabled Disabled	Enable/Disable Source ID embedding in the VANC. Choose one line between lines 4-19 to embed data.
SCTE104	Enabled Disabled	Enable/Disable SCTE104 embedding in the VANC. Choose one line between lines 4-19 to embed data.

SD SDI VBI Embedding

When the MRD 4400 is configured to output SD video the VBI data can be encoded into the vertical blanking as a VBI waveform. The options below allow the user to enable or disable these waveforms.

Setting	Range	Description
TTX	Enabled	Enable/Disable Teletext embedding in the VBI. The line which Teletext will be embedded is dependent on data in the incoming stream.
	Disabled	
WSS	Enabled	Enable/Disable Widescreen Signaling (WSS) embedding in the VBI. WSS is output on line 23 in the VBI.
	Disabled	
VPS	Enabled	Enable/Disable Video Program System (VPS) embedding in the VBI. VPS is output on line 16 in the VBI.
	Disabled	
AMOL	Enabled	Enable/Disable Automated Measurement of Lineups (AMOL) embedding in the VBI. The line which AMOL will be embedded is dependent on data in the incoming stream.
	Disabled	
TVG2X	Enabled	Enable/Disable TV Guide data embedding in the VBI. The line which TVG2X will be embedded is dependent on data in the incoming stream.
	Disabled	
VITC	Enabled	Enable/Disable Vertical Interval Timecode embedding in the VBI. VITC is sourced from the video elementary stream and is embedded on line 14.
	Disabled	
L21 Captions	Enabled	Enable/Disable Line 21 Closed Caption embedding in the VBI. Closed Captions are output on line 21 in the VBI.
	Disabled	

4.2.22 Configuring Secondary SDI Audio Embedding

This menu allows the user to configure SDI embedded audio settings. The MRD 4400 comes standard with the ability to handle up to two audio services. With additional licensing, the MRD 4400 can handle up to four unique audio services. When licensed for four audio services, the user will have four audio pairs available to embed audio in the SDI output. These two groups consist of four pairs, with two pairs to each group. All audio pairs share the same options.

Configure SDI Output

SD Audio

Group 1

Pair 1: Off

Pair 2: Off

Group 2

Pair 1: Off

Pair 2: Off

Apply Cancel

Secondary SDI Embedded Audio Configuration Menu

Setting	Range	Description
Group 1-2	Off	Assigning a <i>PCM</i> audio to a Group Pair will embed the decoded or downmixed two channel audio using the settings defined in Section 4.2.13.
Pair 1-2	Audio 1-4 PCM Audio 1-4 Pass-through	Assigning <i>Pass-Through</i> to a Group Pair will embed unprocessed compressed audio in the SDI

VANC. Selecting Off disables the Group Pair completely.

4.2.23 Configuring Composite Output

This menu allows the user to configure the composite video output (primary and secondary if applicable) of the MRD 4400. Color subcarriers and VBI embedding are configured in this menu. Please note that the composite video output is only active if the output video format is SD.

Configure Primary Composite Output

Video Loss Mode: Display Raster

NTSC Pedestal: Black at 7.5 IRE

525 Standard: NTSC

625 Standard: PAL-BGID

VBI

TTX: Disabled

WSS: Disabled

VPS: Disabled

AMOL: Disabled

TVG2X: Disabled

L21 Captions: Disabled

VITC: Disabled

Apply Cancel

Setting	Range	Description
Video Loss Mode	Disable Composite Display Raster	This option allows the user to define how the composite video output reacts when video is not decoding. If <i>Disable Composite</i> is selected the composite video output is squelched. If <i>Display Raster</i> is selected the composite video output displays the Raster Color defined in Section 4.2.13.
NTSC Pedestal	Enabled Disabled	Enabling the NTSC Pedestal uses the NTSC pedestal (7.5 IRE) for black levels.

525 Standard	NTSC PAL-M	Select the color subcarrier used for 525 line video formats.
625 Standard	PAL-BGID PAL-N	Select the color subcarrier used for 625 line video formats.
Teletext	Enabled Disabled	Enable/Disable Teletext embedding in the VBI. The line which Teletext will be embedded is dependent on data in the incoming stream.
WSS	Enabled Disabled	Enable/Disable Widescreen Signaling (WSS) embedding in the VBI. WSS is output on line 23 in the VBI.
VPS	Enabled Disabled	Enable/Disable Video Program System (VPS) embedding in the VBI. VPS is output on line 16 in the VBI.
AMOL	Enabled Disabled	Enable/Disable Automated Measurement of Lineups (AMOL) embedding in the VBI. The line which AMOL will be embedded is dependent on data in the incoming stream.
TVG2X	Enabled Disabled	Enable/Disable TV Guide data embedding in the VBI. The line which TVG2X will be embedded is dependent on data in the incoming stream.
L21 Captions	Enabled Disabled	Enable/Disable Line 21 Closed Caption embedding in the VBI. Closed Captions are output on line 21 in the VBI.
VITC	Enabled Disabled	Enable/Disable Vertical Interval Timecode (VITC) embedding in the VBI. VITC is sourced from the video elementary stream and is embedded on line 14.

4.2.24 Configuring Analog Audio Output

This menu allows the user to configure the analog output outputs of the MRD 4400. Four analog audio outputs are available. The dBu level of the outputs can be adjusted for each of the four audio outputs. For the Analog Output connector pinout refer to Appendix C.

Configure Analog Audio Output		
Analog Output 1:	Audio 1	Level (dBu): 0.4
Analog Output 2:	Audio 2	Level (dBu): 0.4
Analog Output 3:	Off	Level (dBu): 4
Analog Output 4:	Off	Level (dBu): 4

Apply Cancel

Setting	Range	Description
Analog Output 1-4	Off Audio 1-4	Assign <i>Audio 1-4</i> to an analog audio output for output. Select <i>Off</i> to disable the analog output completely.
Level	-10-4	Level of the analog audio output in dBu.

4.2.25 Configuring Digital Audio Output

This menu allows the user to configure the digital audio outputs of the MRD 4400. The number of outputs available directly correlates with the number of audio services the unit is licensed to support. Up to four digital audio outputs are available.



Setting	Range	Description
Digital Output 1-4	Off Audio 1-4 PCM Audio 1-4 Pass-through	Assigning a <i>PCM</i> audio to a digital output will output the decoded or downmixed two channel audio using the settings defined in Section 4.2.13. Assigning <i>Pass-Through</i> to a digital output will output unprocessed compressed audio. Selecting <i>Off</i> disables the digital output completely.

4.2.26 PID Filter

If the PID/Service Filter license is enabled, the following menus and options will be available for configuration. PID filtering will allow the user to create a new output TS by selecting and dragging one or more services/PIDs from the incoming transport stream into the Selected Services/Pids box or use the currently decoded stream. The user can also configure a TS bitrate for each PID filtered stream and select different table inclusion options.

Service/PID	Bitrate (Mbps)
Service 115 - Contrib Indien	2.606
Service 151 - Radio Reunion	0.201
Service 152 - Radio Mayotte	0.000
Service 154 - Contrib Rad	0.200
Service 155 - Libre 64	0.201
Service 156 - Le Mouv	0.201
Service 157 - RFI Monde	0.201
Service 158 - France Info	0.201
Service 159 - France culture	0.200
Service 160 - France Inter	0.201
Service 180 - France 2 HD	4.814
Service 181 - Arte HD	4.814
Service 182 - France 3 HD	4.815
Service 190 - Radio O	0.201
Service 7501 - IP Reunion	0.000
Service 7502 - IP Mayotte	0.000
Service 8450 - Reunion 1ere	2.262
Service 8457 - Mayotte 1ere	2.261

Setting	Range	Description
Select PID Filter	PID filter 1-10	Select which PID filter to configure
TS Bitrate (Mbps)	.25 to 160	Configure the TS Bitrate for the PID filter stream selected
Table Processing Mode	PSI (MPEG)	Adjusted tables: PAT, PMT Passed tables: CAT, NIT Discarded tables: all remaining
Table Processing Mode	SI (DVB)	Adjusted tables: PAT, PMT, SDT Passed tables: CAT, NIT, EIT, RST, TDT, TOT Discarded tables: TSDT, BAT
Selection Mode	Use Selected Services/PIDs Use Decoded Service	Use Selected Services/PIDs will allow the user to select which services are in the new TS. Use Decoded Service will only include the service that is currently selected for decoding by the MRD 4400

4.2.27 Configuring ASI Output

This menu allows the user to configure the ASI output of the MRD 4400. When enabled this output acts as an active loop output of the active input. For example, if the DVB-S/S2 input card is the current active input the ASI output port will output a demodulated signal of the satellite input.



Setting	Range	Description
Port	Enabled	Enable or disable the ASI output port.
	Disabled	
Source	Unmodified Input	Unmodified Input will pass the incoming TS to the output without applying any BISS or DVB-CI decryption
	Descrambled	Descrambled (or Descrambled and Processed) will output the TS with any applied BISS or DVB-CI decryption.
	Descrambled and Processed	
	Pid Filter 1-10	PID Filter will output the TS from the PID filter menu option.

4.2.28 Configuring the MPEG/IP Outputs

This menu allows the user to configure the MPEG/IP outputs. Each MPEG/IP card has two ports that can be set to receive and/or transmit. This menu is for setting up the transmission of MPEG/IP unicast or multicast transport streams. The menu for Stream 1 and 2 have the same settings. The menu for Streams 3 through 10 will contain the same options as Transmit 1 and Transmit 2 with one exception: Forward Error Correction is only available (if licensed) on Transmit 1 and 2.

Configure MPEG/IP Slot 2 Stream 1

General Settings

Transmit: Enabled

Source: Unmodified Input

Physical Connector: Port 2

Destination IP: 232.50.50.52

Destination Port: 10000

Source Port: 2333

TS Packets Per IP Packet: 7

Differentiated Services: Default

Encapsulation: UDP

Advanced Settings

FEC: Off

FEC Columns: 4

FEC Rows: 4

Apply Cancel

Setting	Range	Description
Transmit	Enabled Disabled	Enable or disable the MPEG/IP transmit group.
Source	Unmodified Input Descrambled Descrambled and Processed Pid Filter 1-10	Unmodified Input will pass the incoming TS to the output without applying any BISS or DVB-CI decryption. Descrambled (or Descrambled and Processed) will output the TS with any applied BISS or DVB-CI decryption. PID Filter will output the TS from the PID filter menu option.
Physical Connector	Port 1 Port 2	The physical connector on the MPEG/IP card that will be used to transmit the output.
Destination IP	Multicast - 224.0.0.0 - 239.255.255.255	When sending to a unicast address the destination IP address must match the receiving device's IP address. When sending a multicast

		the address must be sent within the multicast IP range.
Destination Port	0 - 65535	When sending to a unicast address, the destination port must match the receiving device's port. When sending a multicast, any port within the accepted range can be used, but it is good practice to always choose a port >1030 and an even number
Source Port	0 - 65535	This is the port used by the MRD 4400 to transmit the MPEG/IP stream.
TS Packets Per IP Packet	1-7	The number of TS packets that are contained with a single IP packet. Default is 7. Lowering this value below default increases network overhead.
Differentiated Services	Default Assured Forwarding 1-1 to 4-3 Expedited Forwarding	Define the quality of service (QoS) classification the packets carry when transmitted.
Encapsulation	UDP RTP	Sets the Encapsulation to UDP or RTP.
FEC	Off Columns Columns/Rows	Sets the FEC Type or disables FEC.
FEC Columns	1-20 (Columns) 4-20 (Columns/Rows)	Defines the number of Columns used to construct the FEC Matrix. (Columns * Rows must be ≤ 100.)
FEC Rows	4-20	Defines the number of Rows used to construct the FEC Matrix. (Columns * Rows must be ≤ 100.)

4.2.29 Configuring the MPEG/IP MPE Outputs

This menu allows the user to configure the MPEG/IP Multi-Protocol Encapsulation (MPE) outputs. Each MPE Output allows the user to select an MPE data PID from the transport stream to be output.

Setting	Range	Description
Transmit	Enabled Disabled	Enable or disable transmission of de-encapsulated MPE data.
Physical Connector	Port 1 Port 2	The physical connector on the MPEG/IP card that will be used to transmit the MPE data.
PID		Selected MPE PID from the transport stream to use for MPE output
MAC Filter State	Enabled Disabled	Enable or Disable the filtering of output data based on a MAC address in the selected MPE PID
MAC Address	00:00:00:00:00:00 FF:FF:FF:FF:FF:FF	Filtered MAC address that will be transmitted in the MPE output. All data with other MAC addresses in the selected MPE PID will be discarded

4.2.30 Viewing PSIP Information

To view the PSIP information for the applied TS, select the View PSI Tables button located on the right hand side of the Inputs section. This will open a new window that displays all of the PSIP information for the applied TS. The tables displayed will include PAT, PMT and CAT and tables associated with the stream type (DVB,ATSC). SDT tables will be displayed for DVB streams and MGT,TVCT,EIT, ETT, STT tables will be displayed for ATSC streams.

The screenshot shows a window titled "View PSI Tables" with a tree view on the left and a details pane on the right. The tree view shows "PSI Tables" expanded, with "0 PAT" and "17 SDT" listed. The details pane shows "PAT Details" with the following information:

PAT Details	PID:	0
	Version:	0
	TS ID:	1
	Program Count:	1

Below the PAT details is a table for "PMTs":

PID	Version	Program Number	ES Count
101	0	2	4

A "Close" button is located in the bottom right corner of the window.

Clicking the Refresh button in the upper left corner will update the tables displayed.

4.3 Admin Panel

Main Admin Reporting About

Admin Control Panel

Change Password Profiles SNMP MIBs Diagnostics Update Unit Reboot Reset to Defaults Enable U2D

General Settings

Configure General Settings

Unit Alias: (No Alias)
Protect BIOS-E Injected ID: Yes

Unit Network Configuration

Mode	IP Address	Subnet Mask	Gateway	Hostname	MAC
DHCP	10.0.15.192	255.255.0.0	10.0.1.3	(none)	00:06:4D:01:8B:08

MPEG/IP Network Configuration

Configure Card Slot 2: Default Gateway: Part 1: ICMP Response: Enabled

MPEG/IP	IP Address	Subnet Mask	Gateway	MAC	Link Status	Tx Rate (Mbps)	Rx Rate (Mbps)	QMP
Slot 2 - 1	10.0.110.71	255.255.0.0	10.0.1.3	00:06:4D:01:8C:FF	1000Mbps/Full (Up)	0.000	0.000	V3
Slot 2 - 2	10.0.110.72	255.255.0.0	10.0.1.3	00:06:4D:01:8D:00	N/A (Down)	0.000	0.000	V3

License Information

Apply License Key

Option	Supported	State	Instances
MRD 44710 - HD/SD 4:2:0 Decoding	Yes	Licensed	1
MRD 44840 - 2x->4x Audio Service Decoding Upgrade	Yes	Licensed	1
MRD 44816 - DVB-S2 Advanced Feature	No	Unsupported	1
MRD 44921 - BIOS Desrambling	Yes	Licensed	1
MRD 44925 - IP FEC Output	Yes	Licensed	1
MRD 44991 - Multi-service Desrambling	Yes	Licensed	1
MRD 44992 - SCTE 35-204 Conversion License	Yes	Licensed	1

Date / Time

Configure Date / Time

Update Mode: NTP
Current Date: 11/21/2013
Current Time: 19:02:24
NTP Server: 10.0.1.23

SNMP Communities

Configure SNMP Communities

Read-Only Community: public
Read-Write Community: private

SNMP Trap Managers

Configure SNMP Managers

SNMP Managers

In-Band Control

Configure In-Band Control

In-Band Control: Disabled
PID: 4000
Group: None
Device ID: 00064D018B08
Update Progress: Idle

To access the Admin Control Panel, click on the **Admin** tab. This menu allows the user to control many aspects of the MRD 4400.

4.3.1 Changing Unit Password

The MRD 4400 can be assigned an access password and the current access password can be changed. In order to make changes to passwords, click the  button. A window will appear to enter the current password and new password.









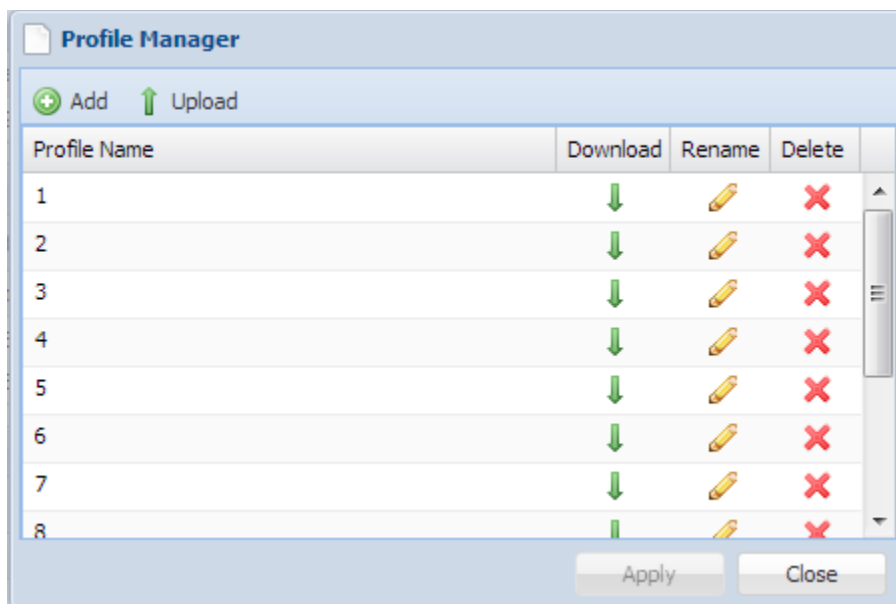

















The dialog box titled "Change Password" contains two input fields: "New Password:" and "Confirm Password:". Below the fields are two buttons: "Apply" and "Cancel".

4.3.2 Profiles

The MRD 4400 has the ability to save all configured settings to multiple profiles. Profiles can be saved locally, renamed and saved to external storage to be used on other MRD 4400s. Profiles can be used to quickly and easily change the configuration of an MRD 4400 to suit different inputs and decoding requirements.



The Profile Manager window displays a table of profiles with columns for Profile Name, Download, Rename, and Delete. The table contains 8 rows of profiles. Below the table are "Apply" and "Close" buttons.

Profile Name	Download	Rename	Delete
1			
2			
3			
4			
5			
6			
7			
8			

Action





Add New Profile

Button

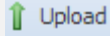

Description

Adds a new profile from current settings. User must name profile before creation is complete.



Upload Profile		Allows the user to browse to external storage or workstation to upload profile to MRD 4400.
Apply Profile		Select a profile from the drop down menu and click this button. The MRD 4400 will apply all settings contained in the profile selected.
Rename Profile		Select a profile from the drop down menu and click this button. The user will be prompted for a new name for the profile.
Delete Profile		Select a profile from the drop down menu and click this button. The user will be prompted to confirm deletion of the profile.
Download Profile		Select a profile from the drop down menu and click this button. The user will be prompted to select a directory to download the profile.

4.3.3 General Settings

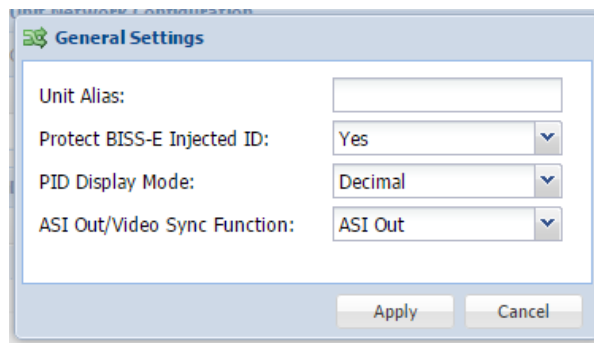
The MRD 4400 can be assigned an alias which is displayed in the upper right hand corner of the web interface. The alias can help define which MRD 4400 the operator is currently logged into. The BISS-E Injected ID for BISS Mode E can also be protected from being accidentally changed. Setting the Protect BISS-E Injected ID to Yes will force the user to unlock the dialog box in the BISS Descrambling configuration menu before allowing any changes to be made. The edit the Unit Alias or protect the BISS-E Injected ID click on the  **Configure General Settings** button. The PID Display mode changes how PID values are displayed in the web interface. The values can either be displayed in decimal or HEX values. The ASI Out/Video Sync Function is for special applications purposes. This should remain set to ASI Out.



4.3.4 Unit Network Configuration

The management port of the MRD 4400 can be configured from the web interface. To make changes to the management port click the  button under the Unit Network Configuration section. Domain name servers can be configured on the MRD clicking the  **Configure Nameservers** button. IP address and web address entries are accepted as Nameserver addresses.

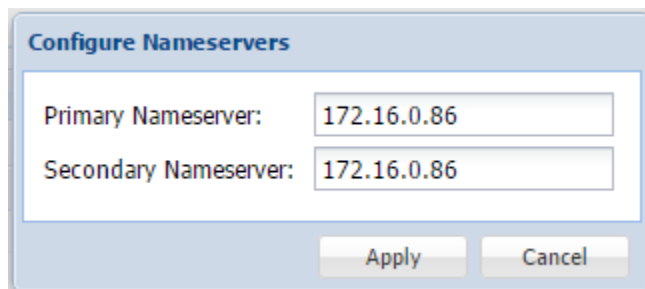

If the MRD 4400 contains a 44127 option card the unit can be configured to have an optional 2nd control port.

NOTE: Exercise extreme caution when performing changes to this menu as network communication can be lost with the MRD 4400.

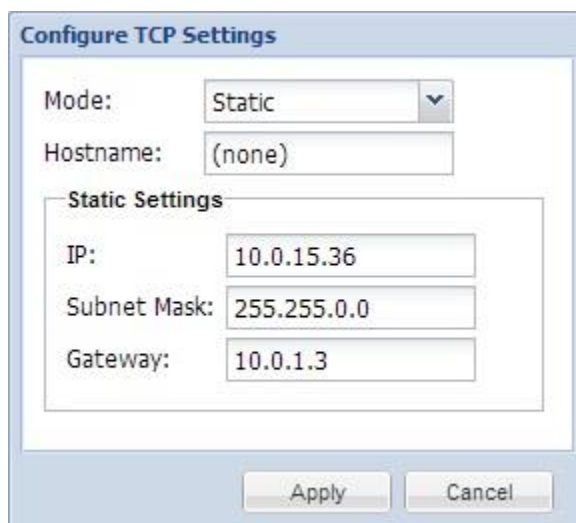

Setting	Range	Description
Mode	DHCP Static	Setting to <i>DHCP</i> will allow the network assign an IP address automatically to the MRD 4400 (if supported). Setting to <i>Static</i> allows the user to manually define all TCP/IP settings for the management port.

Hostname	Valid characters: A through Z 0 through 9 - (hyphen)	This setting allows the user to define an optional unit Hostname.
IP	Four decimal octets: XXX.XXX.XXX.XXX	This option is only available if Static Mode is set. This is the IP address assigned to the management port.
Subnet Mask	255.0.0.0 – 255.255.255.254	This option is only available if Static Mode is set. This is the Subnet Mask assigned to the management port.
Gateway	Four decimal octets: XXX.XXX.XXX.XXX	This option is only available if Static Mode is set. This is the Gateway address assigned to the management port.

The 2nd management port of the MRD 4400 can be configured from the web interface. To make changes to which port is the 2nd management port click, the configure control ports  button under the Unit Network Configuration section.

4.3.5 MPEG/IP Network Configuration

The MPEG/IP card is used to receive MPEG over IP transport streams. The MPEG/IP card supported unicast, multicast, UDP and RTP. The ports of the MPEG/IP card on the MRD 4400 can be configured from the web interface. To configure the Default Gateway and ICMP Response settings click the  **Configure Card** button.



Configure MPEG/IP Card

Slot 2

Default Gateway: Port 1

ICMP Response: Enabled

Apply Cancel

Setting	Range	Description
Default Gateway	Port 1 Port 2	Setting to <i>Port 1</i> uses the gateway address of port 1 as the default gateway. Setting to <i>Port 2</i> uses the gateway address of port 2 as the default gateway.
ICMP Response	Enabled Disabled	Setting to enabled allows the MRD 4400 to respond to ICMP requests (ping). If disabled the MRD 4400 will not respond to these requests.

To configure the TCP/IP settings of the MPEG/IP ports click the  button under the MPEG/IP Network Configuration section next to the corresponding port. The settings for both ports are the same.

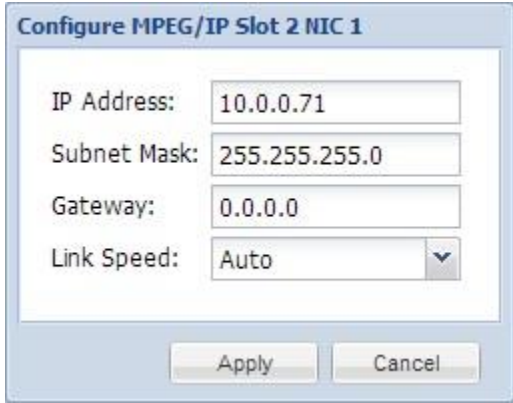

Configure MPEG/IP Slot 2 NIC 1

IP Address: 10.0.0.71

Subnet Mask: 255.255.255.0

Gateway: 0.0.0.0

Link Speed: Auto

Apply Cancel

Setting	Range	Description
IP Address	1.0.0.0 - 126.0.0.0 128.0.0.0 - 191.255.0.0 192.0.1.0 - 223.255.255.0	This setting is the TCP/IP address assigned to the port.
Subnet Mask	255.0.0.0 – 255.255.255.254	This setting is the subnet mask assigned to the port.
Gateway	1.0.0.0 - 126.0.0.0 128.0.0.0 - 191.255.0.0 192.0.1.0 - 223.255.255.0	This setting is the gateway address assigned to the port.
Link Speed	Auto 1000Mbps/Full 1000Mbps/Half 100Mbps/Full 100Mbps/Half 10Mbps/Full 10Mbps/Half	Setting Link Speed to Auto allows the MRD 4400 to determine the link speed of the network. If this is not possible or the user wants to define a link speed select one of the other values available.

4.3.6 Licensing

Certain features of the MRD 4400 require licenses in order to be functional. The interface displays all licenses available as well as the following status:

- License Locked or Unlocked
- License is Supported or Unsupported by the installed hardware

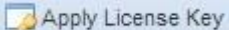
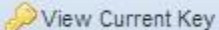
If licenses need to be applied to the MRD 4400 click  button. The menu below will appear where the user can copy and paste the provided license key from Sencore. The currently applied license key can be viewed by clicking the  button.

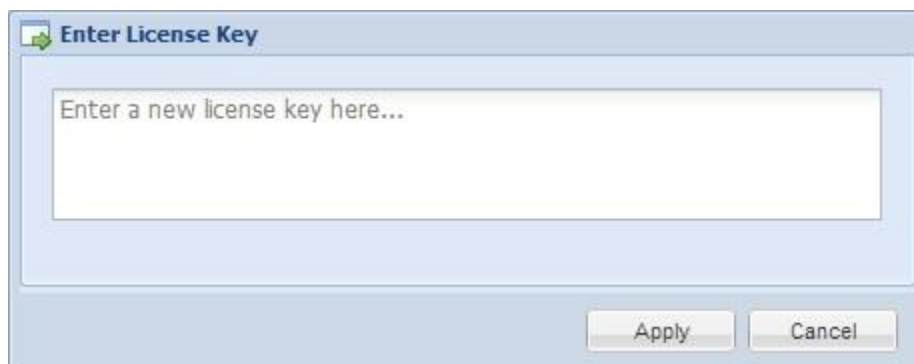

The dialog box titled "Enter License Key" features a large text input field with the placeholder text "Enter a new license key here...". At the bottom right, there are two buttons: "Apply" and "Cancel".

4.3.7 Date/Time

The MRD 4400 can be set to synchronize with an NTP server or a manual data and time can be defined by the user. Click the  button to configure the date and time. These values are used to timestamp entries in the Alarm and Event logs under the Reporting tab.

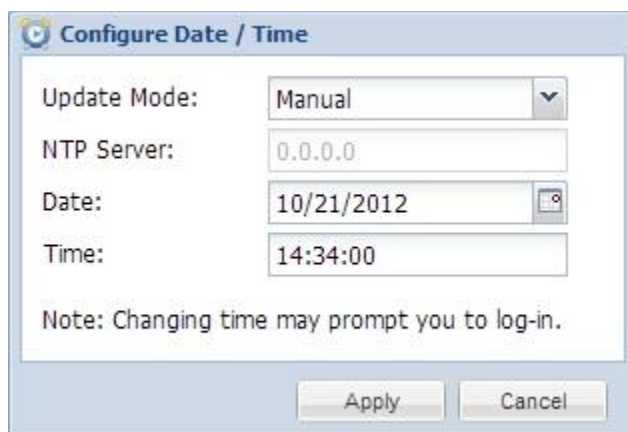

The dialog box titled "Configure Date / Time" contains the following fields:

- Update Mode:** A dropdown menu currently set to "Manual".
- NTP Server:** A text input field containing "0.0.0.0".
- Date:** A date picker field showing "10/21/2012".
- Time:** A time input field showing "14:34:00".

Below the fields is a note: "Note: Changing time may prompt you to log-in." At the bottom right, there are "Apply" and "Cancel" buttons.

Setting	Range	Description
Update Mode	NTP Manual	Setting to <i>NTP</i> uses the local network's NTP server to synchronize date and time. <i>Manual</i> allows the user to define a date and time.
NTP Server	Four decimal octets: XXX.XXX.XXX.XXX	This is the IP Address or Domain Name of the local NTP Server on the network. This setting is only available if Update Mode is set to NTP.

	Domain Name	
Date	MM/DD/YYYY	This setting is the user defined date. A calendar widget can be used to select the data by clicking the  button. This setting is only available if Update Mode is set to Manual.
Time	00:00:00 – 24:00:00	This setting is the user defined time. The time is based on a 24 hour clock. This setting is only available if the Update Mode is set to Manual.

4.3.8 Configuring SNMP

4.3.8.1 SNMP Communities

SNMP Communities define whether users have read-only or read-write SNMP rights. These two communities are given unique names. The default names for these communities are:

- Read –Only Community: public
- Read- Write Community: private

To modify the names of these communities click on the  **Configure SNMP Communities** button.





The image shows a dialog box titled "SNMP Community Strings". It contains two text input fields. The first field is labeled "Read-Only Community:" and contains the text "public". The second field is labeled "Read-Write Community:" and contains the text "private". At the bottom of the dialog box, there are two buttons: "Apply" and "Cancel".

4.3.8.2 SNMP Trap Managers

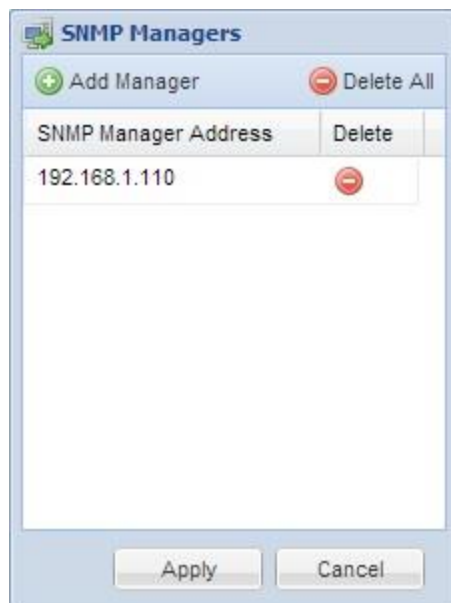
The SNMP trap managers are recipients of SNMP traps sent from the MRD 4400. The following menu allows the user to configure the recipient's IP addresses. To add and remove recipients of the SNMP traps click the  **Configure SNMP Managers** button.

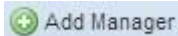













Action	Button	Description
Add Manager		Clicking this button prompts the user for the IP address of the SNMP trap manager.
Delete All		Clicking this button prompts the user to confirm the deletion of all SNMP trap manager IP addresses. If the user confirms deletion all SNMP trap manager IP addresses will be removed.
Delete Single Entry		Highlight a single SNMP trap manager IP address and click this button to delete the entry. A prompt will appear confirming the deletion of IP address.

4.3.8.3 Download SNMP MIB Files

The MRD 4400 stores the SNMP MIB files for the currently installed version of software on the unit. These files can be downloaded directly from the MRD 4400 by clicking on the  button. The screen below will appear where the files can be downloaded and saved off of the unit.

Index of /mibs/

Name	Last Modified	Size	Type
Parent Directory/		-	Directory
 INET-ADDRESS-MIB.MIB	2013-Jan-17 19:45:02	16.3K	application/octet-stream
 SENCORE-CSP-MIB.MIB	2013-Jan-17 19:45:02	66.1K	application/octet-stream
 SENCORE-GLOBAL-REG.MIB	2013-Jan-17 19:45:02	2.3K	application/octet-stream
 SENCORE-MRD4400-MIB.mib	2013-Jan-17 19:45:03	148.5K	application/octet-stream
 SNMP-COMMUNITY-MIB.MIB	2013-Jan-17 19:45:02	15.1K	application/octet-stream
 SNMP-FRAMEWORK-MIB.MIB	2013-Jan-17 19:45:02	21.8K	application/octet-stream
 SNMP-MPD-MIB.MIB	2013-Jan-17 19:45:02	5.3K	application/octet-stream
 SNMP-TARGET-MIB.MIB	2013-Jan-17 19:45:02	22.2K	application/octet-stream
 SNMP-USER-BASED-SM-MIB.MIB	2013-Jan-17 19:45:02	38.2K	application/octet-stream
 SNMP-VIEW-BASED-ACM-MIB.MIB	2013-Jan-17 19:45:02	33.3K	application/octet-stream
 SNMPv2-MIB.MIB	2013-Jan-17 19:45:02	28.6K	application/octet-stream
 SNMPv2-SMI.MIB	2013-Jan-17 19:45:02	8.7K	application/octet-stream
 SNMPv2-TC.MIB	2013-Jan-17 19:45:02	37.1K	application/octet-stream

To Download: Right-Click, Save Link As or Save Target As

4.3.9 Syslog

The MRD 4400 can be configured to send error and event logs formatted in the syslog protocol to a remote user specified Syslog server.

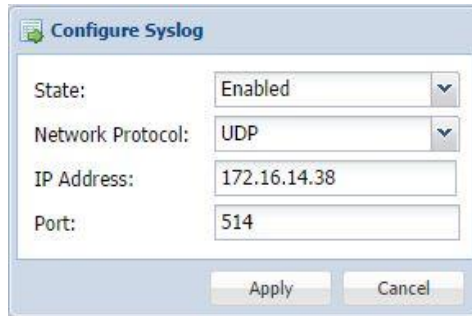

The image shows a 'Configure Syslog' dialog box with the following fields:

- State: Enabled (dropdown menu)
- Network Protocol: UDP (dropdown menu)
- IP Address: 172.16.14.38 (text input)
- Port: 514 (text input)

Buttons: Apply, Cancel

Action	Range	Description
State	Enabled Disabled	Enable or Disable sending messages to Syslog server.
Network Protocol	UDP TCP	Select which network protocol used to transmit to the Syslog server
IP Address	Four decimal octets: XXX.XXX.XXX.XXX	IP of the Syslog server. 0.0.0.0 and 255.255.255.255 are not permitted
Port	0 - 65535	Destination port of the Syslog server

4.3.10 In-Band Control

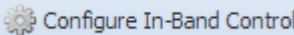
The In-Band Control is used to change settings and receive updates from data within a PID in the incoming TS, as injected by the Sencore CMD 4000. The following menu allows the user to configure the In-Band Control settings. To configure the In-Band Control settings click the  button.





Action	Range	Description
State	Enabled	Enable or Disable the In-Band Control.
	Disabled	
PID	1-8190	Sets the unit to look for commands on the PID that is set.
Group	None	This setting assigns the unit to a corresponding Group or No Group.
	1-128	

4.3.11 Updating the MRD 4400

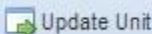
4.3.11.1 Applying Software Updates

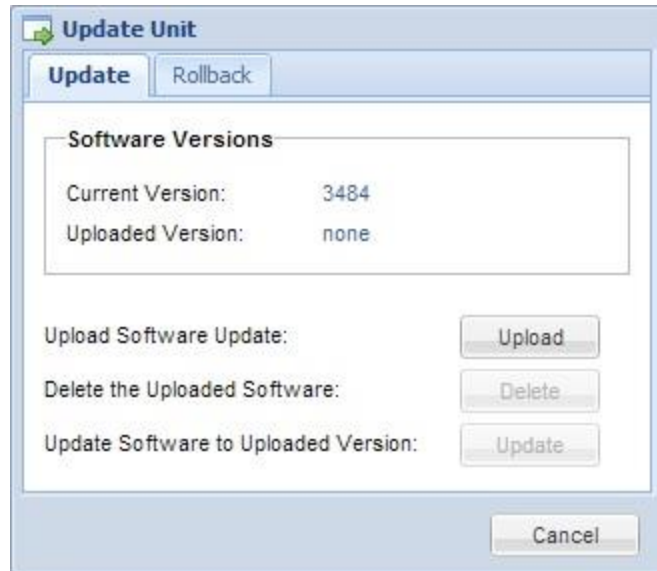
Updates to the MRD 4400 are performed through the web interface. A software update file is provided by Sencore and then uploaded to the unit. Once uploaded, the software update is applied to the unit. To upload software updates to the unit click on the  button. The current version and uploaded version is displayed in the Software Versions section. The MRD 4400 will reboot after a software update is complete.

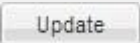

Action	Button	Description
Upload Software Update		To upload software updates to the MRD 4400 click this button. The user will be prompted to navigate to an update file. The file will then upload to the MRD 4400. When complete the MRD 4400 will prompt the user to either apply the update or cancel
Delete the Uploaded Software		Clicking this button prompts the user to confirm the deletion of the software update from the MRD 4400. This will also clear the Uploaded Version status of the Software Versions section.
Update Software to Uploaded Version		Clicking the button starts the software update process. The MRD 4400 will prompt the user to confirm the update. Click Yes to continue or No to cancel.

4.3.11.2 Rollback Software Updates

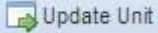
The MRD 4400 is capable of reverting back to a previous version of software using the Rollback feature. The MRD 4400 maintains two separate software images; one is the most current version of software with all current settings and the other is the previous version of software with all settings. To perform a rollback, click the  **Update Unit** button and then click the **Rollback** tab. The MRD 4400 will reboot after the rollback process is complete.

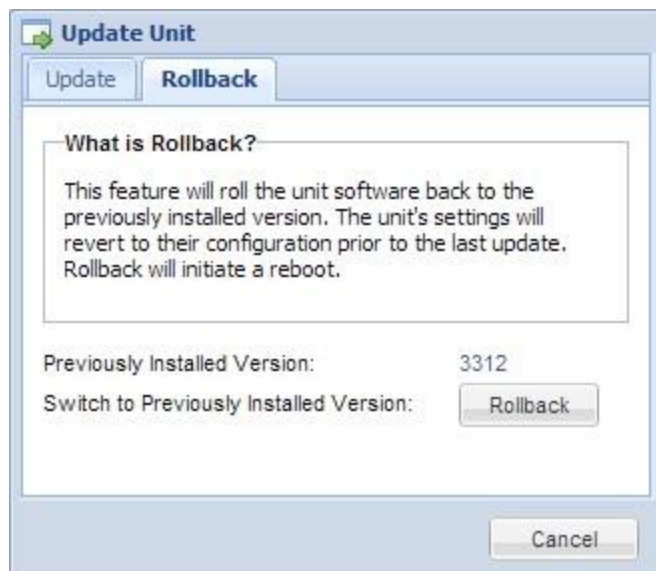

Action	Button	Description
Rollback Software	<input type="button" value="Rollback"/>	Clicking this button starts the Rollback process. The MRD 4400 will prompt the user to confirm the rollback or click cancel to stop the process.

4.3.12 Reboot Unit

The MRD 4400 can be rebooted from the web interface. In order to perform a reboot click the  **Reboot** button. The MRD 4400 will prompt the user to confirm the reboot. Once the reboot is complete the login screen will appear allowing the web interface to be logged into.

4.3.13 Reset Defaults

The MRD 4400 settings can be reset to factory defaults. All settings will be returned to the factory defaults except the network management ports TCP/IP settings. All event logs will be cleared. To reset all settings to default click the  **Reset to Defaults** button. The MRD 4400 will prompt the user to confirm the reset.

4.4 Reporting Panel



State	Name	Location	Last Changed
ⓘ	Transport Stream Not Present	Unit	12/17/2012 16:27:19
ⓘ	Link Loss Error	MPEG/IP Slot 1 NIC 1	12/17/2012 16:27:31
ⓘ	IP Loss Error	Input MPEG/IP 2-1	12/17/2012 16:27:36
ⓘ	TS Sync Loss	Input MPEG/IP 2-1	12/17/2012 16:27:31

The **Reporting** tab in the MRD 4400 contains logs for active alarms currently affecting the unit and an event log. The active alarms are updated periodically in order to reflect the real-time state of the unit. Once an error is cleared it will be cleared from the active alarms window. The event log can be used to view alarm and event history. Both the active alarm and event logs can be configured to hide or change the behavior of alarms and events.

4.4.1 Active Alarms

Clicking on the **Alarms** button displays the Active Alarms menu. This list displays all of the active alarms currently affecting the unit. There are four columns in the log that display different types of information.

State	Name	Location	Last Changed
ⓘ	Video Not Decoding	Decoder	12/17/2012 16:28:27
ⓘ	Link Loss Error	MPEG/IP Slot 1 NIC 1	12/17/2012 16:28:45
ⓘ	Link Loss Error	MPEG/IP Slot 1 NIC 2	12/17/2012 16:28:41
ⓘ	Input Video Unsupported	Decoder	12/17/2012 16:28:27





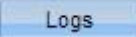
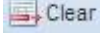
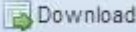

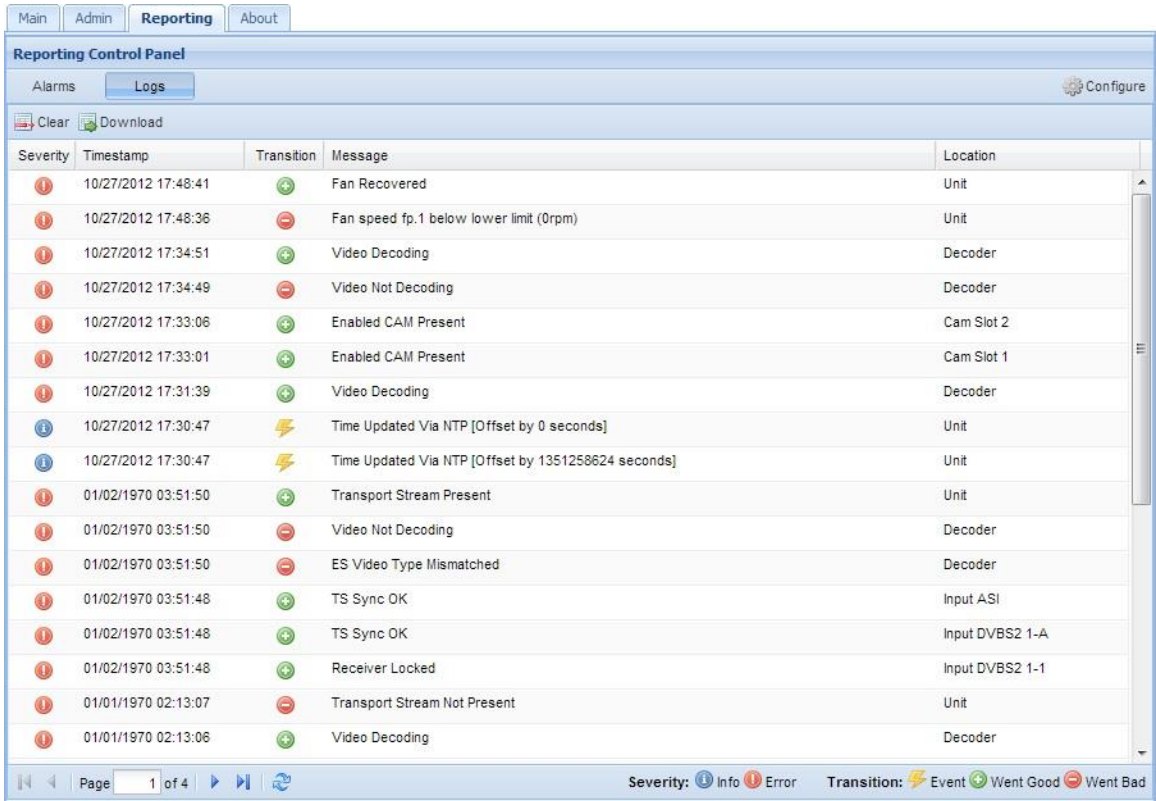



























Title	Description
State	This column displays the nature of the alarm. The  icon means the log entry is informational and is not an error. The  icon means the log entry is an active alarm.
Name	This column displays the description of the error. The function that is experiencing an error condition is described here.
Location	This column displays the hardware or function that is experiencing the active error.
Last Changed	This column displays the data and time the error was raised. This data and time correlates with the Date and Time settings configured in Section 4.3.7.





4.4.2 Event Logs

Clicking on the  button displays the Event Log menu. This list displays all of the events and alarms that have affected the unit. The MRD 4400 stores up to four days' worth of logs. If the unit is rebooted or powered off and on the event logs are cleared. The logs can be cleared manually by clicking the  button. The logs can be downloaded as a .tsv file and saved to an external location by clicking the  button. There are five columns in the log that display different types of information.









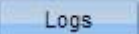

The screenshot shows the 'Reporting Control Panel' with the 'Logs' tab selected. The table below represents the data shown in the log:

Severity	Timestamp	Transition	Message	Location
	10/27/2012 17:48:41		Fan Recovered	Unit
	10/27/2012 17:48:36		Fan speed fp.1 below lower limit (0rpm)	Unit
	10/27/2012 17:34:51		Video Decoding	Decoder
	10/27/2012 17:34:49		Video Not Decoding	Decoder
	10/27/2012 17:33:06		Enabled CAM Present	Cam Slot 2
	10/27/2012 17:33:01		Enabled CAM Present	Cam Slot 1
	10/27/2012 17:31:39		Video Decoding	Decoder
	10/27/2012 17:30:47		Time Updated Via NTP [Offset by 0 seconds]	Unit
	10/27/2012 17:30:47		Time Updated Via NTP [Offset by 1351258624 seconds]	Unit
	01/02/1970 03:51:50		Transport Stream Present	Unit
	01/02/1970 03:51:50		Video Not Decoding	Decoder
	01/02/1970 03:51:50		ES Video Type Mismatched	Decoder
	01/02/1970 03:51:48		TS Sync OK	Input ASI
	01/02/1970 03:51:48		TS Sync OK	Input DVBS2 1-A
	01/02/1970 03:51:48		Receiver Locked	Input DVBS2 1-1
	01/01/1970 02:13:07		Transport Stream Not Present	Unit
	01/01/1970 02:13:06		Video Decoding	Decoder

Title	Description
Severity	This column displays the nature of the alarm. The  icon means the log entry is informational and is not an error. The  icon means the log entry is an active alarm.
Timestamp	This column displays the data and time the error was raised or cleared. This data and time correlates with the Date and Time settings configured in Section 4.3.7.
Transition	This column displays when an alarm transition from a bad to good state. When an error is raised the  icon is displayed. When an error is cleared the  icon is displayed. When an event takes place the  icon is displayed.
Message	This column displays the description of the error or event. The function or hardware that experienced the event or error is described here.
Location	This column displays the hardware or function that experienced the alarm or event.

4.4.3 Configuring the Logs

The MRD 4400 allows the user to configure alarms and events. Events and alarms can be hidden, set to send SNMP traps or close a relay when active. In order to configure these options click the  button while in the  section of the  tab. The  tab allows the user to configure the alarms reported by the MRD 4400. The  tab allows the user to configure the events reported by the MRD 4400. Each column and its function are described below. A user configured time offset can also be applied to allow viewing the logs in a local time zone.

Title	Description
Name	This column displays the name of the error or condition. This is informational data; no options can be set here.
Location	This column displays the hardware or function that the alarm or event applies to. This is informational data; no options can be set here.
Log	Checking the box in this column creates an entry in the event log in the case this error or event is raised. If this box is unchecked this error or event will be hidden and not logged if raised.
Log Severity	This column is only available in the  tab This option allows the user to set the severity of the error to Info or Error. If Info is selected in the drop down box the  icon will displayed in the event log. If Error is selected the  icon will be displayed in the event log.
Alarm	This column is only available in the  tab This option allows the user to enable or disable this alarm in the Active Alarms log. If checked

the alarm will be displayed in the Active Alarms log if raised. If this box is unchecked this error will be hidden.

SNMP Trap	This column allows the user to send an SNMP Trap if this alarm is raised. If this box is checked an SNMP Trap is sent when this alarm is raised. If this box is unchecked an SNMP is not sent.
Relay	This column allows the user to set a Relay closure if this alarm is raised. If this box is checked a Relay will be closed. If this box is unchecked a Relay will not be closed. See Appendix C for pinout.
Relay #	This column allows the user to select which of the three relays available on the MRD 4400 will be closed when the alarm is raised.
Relay Duration	This column is only available in the Events tab. This option allows the user to define the length of time in milliseconds the relay will be closed after the event is logged. This setting can be configured from 100-1000 milliseconds.

4.5 About Panel

Under the **About** tab, there are no user definable parameters but there is information about software versions currently installed, which licenses are installed, how to contact Sencore, and third party software information.

Section 5 Appendices



Introduction

This section includes the following appendices:

Appendix A	– Acronyms and Glossary	100
Appendix B	– Error and Event List.....	103
Appendix C	– Specifications.....	106
Appendix D	– Pinouts for Analog Audio and Relay Connectors	117
Appendix E	– MRD 4400 Audio Explanation	119
Appendix F	– MRD 4400 Discrete Audio Configuration	122
Appendix G	– Open Source Software.....	123
Appendix H	– Warranty	125
Appendix I	– Support and Contact Information	125

Appendix A – Acronyms and Glossary

8VSB: Vestigial sideband modulation with 8 discrete amplitude levels.

16VSB: Vestigial sideband modulation with 16 discrete amplitude levels.

AAC: Advanced Audio Coding

AC-3: Also known as Dolby Digital

AES: Audio Engineering Society

AFD: Auto Format Descriptor

ASI: Asynchronous Serial Interface

ATSC: Advanced Television Systems Committee

AV: Audio Video

Bit Rate: The rate at which the compressed bit stream is delivered from the channel to the input of a decoder.

BNC: British Naval Connector

BPS: Bits per second.

CAM: Conditional Access Module

CAT: Conditional Access Table

CAT6: Category 6 – Cable standard for gigabit Ethernet

CC: Closed Caption

CI: Common Interface

CoP: Code of Practice

CRC: Cyclic Redundancy Check

CVCT: Cable Virtual Channel Table

dB: Decibel

DDPlus: Dolby Digital Plus

DHCP: Dynamic Host Configuration Protocol

DPI: Digital Program Insertion

DTVCC: Digital Television Closed Captioning

DVB: Digital Video Broadcasting

EBU: European Broadcasting Union

EIA: Electronic Industries Alliance

EIT: Event Information Table

EPG: Electronic Program Guide

ETM: Extended Text Message

ETT: Extended Text Table

Event: An event is defined as a collection of elementary streams with a common time base, an associated start time, and an associated end time.

FCC: Federal Communications Commission

FEC: Forward Error Correction

Field: For an interlaced video signal, a “field” is the assembly of alternate lines of a frame. Therefore, an interlaced frame is composed of two fields, a top field and a bottom field.

Frame: A frame contains lines of spatial information of a video signal. For progressive video, these lines contain samples starting from one time instant and continuing through successive lines to the bottom of the frame. For interlaced video a frame consists of two fields, a top field and a bottom field. One of these fields will commence one field later than the other.

HANC: Horizontal Ancillary

HD: High Definition

High level: A range of allowed picture parameters defined by the MPEG-2 video coding specification which corresponds to high definition television.

I/O: Input/Output

IP: Internet Protocol

Kbps: 1000 bit per second

LED: Light Emitting Diode

LNB: Low-Noise Block

MAC: Medium Access Control

Main level: A range of allowed picture parameters defined by the MPEG-2 video coding specification with maximum resolution equivalent to ITU-R Recommendation 601.

Main profile: A subset of the syntax of the MPEG-2 video coding specification that is expected to be supported over a large range of applications.

Mbps: 1,000,000 bits per second.

MER: Modulation Error Ratio

MGT: Master Guide Table

MIB: Management Information Base

MP@HL: Main profile at high level.

MP@ML: Main profile at main level.

MPEG: Refers to standards developed by the ISO/IEC JTC1/SC29 WG11, *Moving Picture Experts Group*. MPEG may also refer to the Group.

MPEG-2: Refers to ISO/IEC standards 13818-1 (Systems), 13818-2 (Video), 13818-3 (Audio), 13818-4

MPTS: Multiprogram Transport Stream

MRD: Modular Receiver Decoder

NTP: Networking Time Protocol

NTSC: National Television System Committee

OSD: On Screen Display

PAL: Phase-Alternating Line

PAT: Program Association Table

PCM: Pulse-Code Modulation

PCR: Program Clock Reference

PCM: Pulse-code Modulation

PID: Packet Identifier. A unique integer value used to associate elementary streams of a program in a single or multi-program transport stream.

PMT: Program Map Table

Profile: A defined subset of the syntax specified in the MPEG-2 video coding specification

Program specific information (PSI): PSI consists of normative data which is necessary for the demultiplexing of transport streams and the successful regeneration of programs.

Program: A program is a collection of program elements. Program elements may be elementary streams. Program elements need not have any defined time base; those that do have a common time base and are intended for synchronized presentation.

PTS: Presentation Time Stamp

QAM: Quadrature Amplitude Modulation

QPSK: Quadrature Phase-Shift Keying

RDS: Receiver Decoder System

RF: Radio Frequency

RGBHV: Red, Green, Blue, Horizontal, Vertical
RO: Read Only
RPM: Revolutions Per Minute
RRT: Rating Region Table
RS-232: Recommended Standard. A standard for serial binary data interconnection.
RU: Rack Unit
RW: Read/Write
SD: Standard Definition
SDI: Serial Digital Interface
SFP: Small Form-Factor Pluggable
SI: System Information
SMPTE: Society of Motion Pictures and Television Engineers
SNMP: Simple Network Management Protocol
SPTS: Single Program Transport Stream
SSRC: Synchronization Source
STD input buffer: A first-in, first-out buffer at the input of a system target decoder for storage of compressed data from elementary streams before decoding.
STD: System Target Decoder. A hypothetical reference model of a decoding process used to describe the semantics of the Digital Television Standard multiplexed bit stream.
STT: System Time Table
TS: Transport Stream
TVCT: Terrestrial Virtual Channel Table
UTC: Coordinated Universal Time
VANC: Vertical Ancillary
VBI: Video Blanking Interval
VCT: Virtual Channel Table. Used in reference to either TVCT or CVCT.
XLR: Cannon “X” series connector, with a Latch, and Rubber around the contacts.
YPbPr: Component Red, Green, Blue

Appendix B – Error and Event List

Error	Description
12V Supply Error	Voltage on 12V rail has exceeded safe operational range.
3.3V Supply Error	Voltage on 3.3V rail has exceeded safe operational range.
5V Supply Error	Voltage on 5V rail has exceeded safe operational range.
AFD Not Present	Auto Conversion is enabled in Video Service configuration but the stream does not contain an AFD code.
ANC/VBI Line Conflict - AFD	The VANC line AFD is currently set to be embedded on is conflicting with another line of data in the VANC.
ANC/VBI Line Conflict - AMOL	The VANC line AMOL is currently set to be embedded on is conflicting with another line of data in the VANC.
ANC/VBI Line Conflict - CC	The VANC line CC is currently set to be embedded on is conflicting with another line of data in the VANC.
ANC/VBI Line Conflict – EN301775	The VANC line EN301775 is currently set to be embedded on is conflicting with another line of data in the VANC.
ANC/VBI Line Conflict – OP47	The VANC line OP47 is currently set to be embedded on is conflicting with another line of data in the VANC.
ANC/VBI Line Conflict – RDD11	The VANC line RDD11 is currently set to be embedded on is conflicting with another line of data in the VANC.
ANC/VBI Line Conflict – SCTE127	The VANC line SCTE127 is currently set to be embedded on is conflicting with another line of data in the VANC.
ANC/VBI Line Conflict – SMPTE2038	The VANC line SMPTE2038 is currently set to be embedded on is conflicting with another line of data in the VANC.
ANC/VBI Line Conflict – Source ID	The VANC line Source ID is currently set to be embedded on is conflicting with another line of data in the VANC.
ANC/VBI Line Conflict – System Timecode	The VANC line Timecode is currently set to be embedded on is conflicting with another line of data in the VANC.
ANC/VBI Line Conflict - Teletext	The VANC line Teletext is currently set to be embedded on is conflicting with another line of data in the VANC.
ANC/VBI Line Conflict – TVG2X	The VANC line TVG2X is currently set to be embedded on is conflicting with another line of data in the VANC.
ANC/VBI Line Conflict - VII	The VANC line VII is currently set to be embedded on is conflicting with another line of data in the VANC.
ANC/VBI Line Conflict - VPS	The VANC line VPS is currently set to be embedded on is conflicting with another line of data in the VANC.
ANC/VBI Line Conflict - WSS	The VANC line WSS is currently set to be embedded on is conflicting with another line of data in the VANC.
Audio Not Decoding	Audio is corrupted in incoming stream or format is not supported.

Auto Video Format Error	MRD 4400 is unable to determine the native incoming video in order to format output.
BISS Conflicting PIDs	PIDs selected to be descrambled by one BISS key are already assigned to be descrambled by another BISS key.
BISS Service Not Found	Service that BISS key is assigned to descramble is not present in the incoming stream.
Backup Input Active Condition	Primary input is currently in a failed condition and the MRD 4400 has failed over to the Backup input.
Bitrate Exceeded Error	Total incoming transport stream bitrate has exceeded 213 Mbps.
CAM Descramble Fail	CAM Module is not descrambling selected pids or services
CAM Not Present	DVB-CI Descrambling is enabled but CAM Module is not installed.
CAM PID Not Found	PID selected to be descrambled by the CAM is not present in the incoming stream.
ES Type Mismatch	Elementary stream type does not match the stream type defined by the user.
FEC Reception Error	Packets in incoming IP stream cannot be repaired with forward error correction.
Fan Speed Below Lower Limit	Cooling fan in the MRD 4400 has failed.
Genlock Not Present	Genlock reference is enabled but not present.
IP Loss Error	No IP packets have been received by the MPEG/IP card for two seconds.
ISI Not Found	ISI value defined by the user is not found in the incoming multistream signal.
Incompatible Genlock Reference	External genlock reference is not compatible with output video format.
Input Video Unsupported	Native format of incoming video is not a supported video format.
LNB Power Error	LNB Power is enabled but the MRD 4400 is detecting power is being provided by another source, there is excessive current drain or an overvoltage has occurred.
Link Loss Error	Physical IP link is not present on the MPEG/IP card.
Loss of Carrier Lock	Receiver carrier lock source is lost.
Low Level	8VSB/QAM RF Level is below the user settable threshold
Low Mer	8VSB/QAM MER is below the user settable threshold
Multistream Mode Input Mismatch	Multistream Mode is enabled and input signal is not multistream capable or Multistream Mode is disabled and input signal is multistream capable.
No Services Detected	Service Lock service selection mode is enabled but no services are present in the active input transport stream.
Pid Filter Overflow Error	Configured PID Filter TS rate is too low.

Pid Filter Selection Not Present	Selected Service or PID is not present for inclusion in the output PID filter TS.
Power Supply Error	Power is lost to one of the Redundant Power Supplies
RDD11 Overflow	RDD11 data cannot fit into the VANC embedding line selected.
RTP Reception Error	Uncorrectable out of order or duplicate packets are present in incoming IP stream.
SCTE35 Heartbeat Timeout	The user settable time limit has been exceeded between SCTE35 messages.
Selected Audio PID Not Present	PID Locked mode is set as service selection mode and audio PID defined by user is not present in the incoming stream.
ES Sync Error Condition	One of the in-use elementary streams is not synchronized to the PCR
Selected PCR PID Not Present	PID Locked mode is set as service selection mode and PCR PID defined by user is not present in the incoming stream.
Selected SCTE35 PID Not Present	PID Locked mode is set as service selection mode and SCTE35 PID defined by user is not present in the incoming stream.
Selected Video PID Not Present	PID Locked mode is set as service selection mode and video PID defined by user is not present in the incoming stream.
Service Not Found	Service Lock service selection mode is enabled but service defined by user is not present in the incoming stream.
Temperature Error	The MRD 4400 has detected the internal temperature is 60 degrees Celsius or above.
Transport Error Indicator	The MRD 4400 has detected that the transport stream error indicator is present on the active input.
Transport Stream Not Present	The MRD 4400 has detected that the transport stream from the active input is no longer present.
TS Sync Loss	Transport stream sync for IP stream is not detected.
Unicast Receiver Not Found Error	The MRD 4400 cannot discover the destination for the unicast IP stream within 10 seconds after the initial ARP is sent.
Unlicensed Modulation	Input stream on active input is either 16APSK or 32APSK and the modulations are no licensed on the MRD 4400.
Unlicensed VCM/Multistream	Input stream on the active input contains a multistream signal and the MRD 4400 is not licensed for multistream.
Video Not Decoding	The configured service or video PID to be decoded is not being successfully decoded by the MRD 4400.

Appendix C – Specifications

MRD 4400 – Base Unit

Includes –	Display, keypad, embedded controller, chassis/case, power supply/line cord
System –	
Display Type:	LCD
Display Configuration:	240 pixels by 64 pixels
Keypad:	Snap-dome Membrane
Front Panel Lockout:	Password control, up to 8 alpha-numeric characters (no punctuations or spaces allows)
Configurations Allows:	Single video decoder with up to two option cards
Rear Panel:	Fixed inputs and outputs with two option card slots. Option cards not field upgradeable.
Remote Operation/Update Interface –	
Type:	Ethernet, 10/100
Rear Panels indicators:	Link (Green LED), Activity (Amber LED)
Connector:	RJ45
Front Panel Indicators –	
Error LED:	Red indicates error is occurring Off indicates no errors detected
INPUT LED:	Green indicates valid input is present Off indicates no valid input
Operating Altitudes	0 to 10000 feet
Monitor and Control Interfaces –	
Web server GUI:	HTTP via web browsing for control & monitoring
Front Panel:	Control & monitoring
SNMP:	Control & monitoring
AC Power –	
Operating Voltage:	100-240VAC
PSU Max Power:	150W
Current Draw:	Base Unit with no option cards – 38-40W
	Base Unit with active ASI input – 54-55W
	MPEG/IP option card with active input – 2-3W (additional)
	DVB-S/S2 option card with active input and LNB load of 19V @ 500mA – 8-9W (additional)
	DVB-CI Module option with 2 CAM Modules installed – 2-3W (additional)
	8VSB/QAM option card with active input – 2-3W (additional)
Max Power Draw:	70-72W
Frequency:	48-63Hz
Connector:	IEC C14

Line Cord:	Detachable, 3-prong
Dual Redundant AC Power Option–	
Operating Voltage:	100-240VAC
PSU Max Power:	150W
Current Draw:	Base Unit with no option cards – 38-40W
	Base Unit with active ASI input – 54-55W
	MPEG/IP option card with active input – 2-3W (additional)
	DVB-S/S2 option card with active input and LNB load of 19V @ 500mA – 8-9W (additional)
	DVB-CI Module option with 2 CAM Modules installed – 2-3W (additional)
	8VSB/QAM option card with active input – 2-3W (additional)
Max Power Draw:	70-72W
Frequency:	50/60Hz
Connector:	IEC C14
Line Cord:	Detachable, 3-prong
DC Power –	
Operating Voltage:	36-72V DC
PSU Max Power:	200W
Current Draw:	Base Unit with no option cards – 38-40W
	Base Unit with active ASI input – 54-55W
	MPEG/IP option card with active input – 2-3W (additional)
	DVB-S/S2 option card with active input and LNB load of 19V @ 500mA – 8-9W (additional)
	DVB-CI Module option with 2 CAM Modules installed – 2-3W (additional)
	8VSB/QAM option card with active input – 2-3W (additional)
Max Power Draw:	70-72W
Connector:	2 pin terminal block

Genlock Interface (MRD 44041 and 44001) Adds –	
Genlock Connector:	75Ω Female BNC
Input Impedance:	10kΩ
Return Loss:	≥20 dB, 0Mhz to 8 Mhz
Drive Level:	1.0 Vpp ±10%
Genlock Capability –	HD – Adjustment of pixels and lines. Max number of dependent on video mode. SD – Adjustment of subcarrier, pixels and lines.
Supported Genlock References:	NTSC Black Burst PAL-B/G/I/D/M/N Black Burst 1080i x 1920 @ 25, 29.97 and 30fps 1080p x 1920 @ 23.97, 24, 25, 29.97, and 30fps 720p x 1280 @ 50, 59.94 and 60fps

Video Decoding Features

General –	
TS Data Rate:	.25-200 Mb/s
Video Decoder –	
Video Profiles and Levels:	MPEG-2 MP@HL H.264 HiP @4.2 H.264 Constrained BP @4.2 HD 4:2:0 License (MRD 44710) Adds – MPEG-2 HP@HL (HD Formats) H.264 up to HP@4.2 (HD Formats) HEVC Decode Module (44265) and HEVC Decoding license (44765) Adds- HEVC Main and Main 10 Profiles up to Level 3, Main Tier (SD only) HEVC Decode Module (44265) and HEVC Decoding license (44765) with HD 4:2:0 License (MRD 44710) Adds- HEVC Main and Main 10 Profiles up to Level 4, High Tier (HD up to 1080p30 30Mbps)
Video Bit Rate:	MPEG-2 1-100Mb/s (dependent on profile) H.264 CABAC Entropy Coded 1 - 80Mb/s CAVLC Entropy Coded 1 - 100Mb/s.
Video Formats:	Base Unit – 576i x 720 (4x3 or 16x9) @ 25Hz 576i x 704 (4x3 or 16x9) @ 25hz 576i x 544 (4x3 or 16x9) @ 25hz 480i x 720 (4x3 or 16x9) @ 29.97Hz HD Video Output License (MRD 44710) Adds – 1080i x 1920 (16x9) @ 25, 29.97 and 30Hz 1080p x 1920 (16x9) @ 23.97, 24, 25, 29.97 and 30Hz 720p x 1280 (16x9) @ 50, 59.94, and 60Hz

SDI (Serial Digital Interface) Video Out –

SDI Standards:	Base Unit – SD-SDI ANSI/SMPTE S259M
	HD Video Output License (MRD 44710) Adds – HD-SDI ANSI/SMPTE 292M
Connector:	75Ω Female BNC
Return Loss:	≥15 dB, 5Mhz to 1.5GHz ≥10 dB, 1.5 GHz to 3.0GHz
Drive Level:	800 mVpp ±10%
Data Bit Rate:	HD-SDI – 1.5 Gb/s SD-SDI – 270Mb/s
Display Modes:	HD – Pillarbars, Cropped, Anamorphic SD – Letterbox, Cropped, Anamorphic

Simultaneous SDI (Serial Digital Interface) Video Out –

SDI Standards:	Option Card – SD-SDI ANSI/SMPTE S259M
Connector:	75Ω Female BNC
Return Loss:	≥15 dB, 5Mhz to 1.5GHz
Drive Level:	800 mVpp ±10%
Data Bit Rate:	SD-SDI – 270Mb/s
Display Modes:	16x9 – Pillarbox, Center-Cut, Anamorphic 4x3 – Letterbox, Center-Cut, Anamorphic

Composite Video Out –

Video Format Standards:	SMPTE 170M-2004, NTSC, PAL-B/G/I/D/M/N
Connector:	One 75 Ω ±10% Female BNC (CVBS)
Return Loss:	>25dB, DC to 6.0 MHz
Frequency Response:	± 0.7dB From 0 to 4.00MHz
Drive Level	140 IRE (1.0Vpp) ±2 IRE
Chroma to Luma Delay:	±26ns Max
Field Time Distortion:	<2% (± 3 IRE)
Line Time Distortion:	< 1% (± 1 IRE)
Short Time Distortion:	< 2% (± 3 IRE)
Group Delay	± 50nS
K factor rating:	< 2.5%
Differential Gain:	<4%
Differential Phase:	<1.5° degrees
Signal to Noise Ratio:	≥55 dB weighted

Digital Video Out –

Digital Video Standard:	SDA-HDMI-OM-E Rev A
Connector:	HDMI-type Female Type-A

Audio Decoding Features

Number of Audio Services:	Base Unit – 2 Audio Services
---------------------------	---------------------------------

4 Audio Service Decode License (MRD 44840) Adds –
2 Audio Services (4 total)

Audio Codecs Supported: Dolby Digital (AC-3) & Plus (EAC-3) AAC-LC, HE-AAC, & HE-AACv2
MPEG1L2 & MPEG2L2
Linear PCM & Dolby E (Pass-through)

Output Formats: Digital Pass-through
PCM (Decoded Discrete channels for 5.1 sources or Downmixed for 5.1 Sources)
Analog (Decoded Discrete channels for 5.1 sources or Downmixed for 5.1 Sources)

Audio Output Features

AES Outputs – 4x 75Ω BNC AES3/EBU Unbalanced
Analog Outputs –
Output Type: Balanced, 2 channel pairs (+/-, L/R)
Connector: 2x High density 15-pin D-sub, male
Impedance: <100Ω Nominal Output Impedance

Max Output Level: +24dBu @ 0dBfs
Adjustable down to +10dBu by 0.5dB steps.

Conditions for Measurement: ≥600Ω Load Impedance
–20dBFS encoded TS source
Output level is adjusted to +4 dBu @ -20 dBFS

THD+N: < 0.01% from 20 Hz to 20Khz
Dynamic Range: >104 dB
Signal to Noise Ratio: >80 dB

Crosstalk: < -80dB from 20Hz to 20kHz
Frequency Response: ±0.5dB 20Hz to 20kHz,
Optional Breakout Cables: 4x XLR Breakout Cable (MRD_AUD_OPT_XLR)
4x BNC Breakout Cable (MRD_AUD_OPT_BNC)
1x Terminal Block (MRD_AUD_OPT_TERM)

SDI Embedded Audio Output Standards:
SMPTE 272M (for SD-SDI)
SMPTE 299 (for HD-SDI)
Density: 4 Audio Pairs
Sampling Frequency: 48 kHz

Ancillary Data Support

SDI VANC Data Types: AFD (SMPTE 2016)
Closed Captions (CEA-708)
OP-47 (SMPTE RDD-08)
SMPTE RDD-11
TVG2X, AMOL-48/96 (SCTE-127)
Teletext/WSS/VPS (SMPTE-2031)
Time Code (SMPTE 12M-2)
SMPTE2038
Source ID
SCTE104 (SMPTE 2010)

SDI HANC Data Types:	VII (SMPTE RP-186)
VBI Waveforms (SDI/Composite):	Time Code (SMPTE 12M-2)
	Line 21 Captions (CEA-608)
	TVG2X, AMOL-48/96 (SCTE-127)
	Teletext (EN300706)
	WSS (EN300294)
	VPS (EN300231))
Synchronization with video :	Timecode in VBI (SMPTE 12M-1)
	Frame Accurate

Video Overlay Support

Closed Caption Overlays:	CEA-608, CEA-708, or SCTE-20
DVB-Subtitle Overlays:	HD/SD with Auto Scaling (EN 300743)

ASI Input and Output Features

General –	
Connector:	2x BNC, Female
Impedance:	75Ω
Return Loss:	≥15dB, 3.5 to 270 MHz
ASI Serial TS Input / Output –	
Number of ASI Inputs:	1 or 2 (rev j or later)
Number of ASI Outputs:	1 (non loop-through) or 2 (rev j or later)
Standard:	EN50083-9 (V2:3/98) DVB ASI
Data Bit Rate:	270 Mb/s
Maximum TS Rate:	200 Mb/s
Minimum TS Rate:	250 Kb/s
Packet Sizes	Input:188 and 204 bytes Output: 188 bytes
Modes Supported:	Burst, Byte and Inverted

DVB-CI Descrambling Module Option

CAM Decryption –	
General –	
Compatibility Standard:	DVB-CI EN 50221
Number of CAM Slots:	2
Auto CAM insertion/removal detection:	Yes
CAM Usage:	Selectable, Enable/Disable
CAM Name Display:	Yes
Multicrypt Support:	Yes
Decryption Selection –	
Elementary Stream types:	Video (MPEG2 & H264), Audio
Selection Modes:	Base Unit – Decoded Elementary Streams
	Multi-Service Descrambling License (MRD 44991)
	Adds –
	Individually selectable elementary streams
Maximum TS bitrate	DVB-CI – 100Mb/s
CAS Supported –	All major CA vendors supported

BISS Descrambling Option

Compatibility Standard:	DVB-CSA
Supported Modes:	Base Unit – None
	BISS Descrambling License (MRD44921) Adds – Mode 1, Mode E, Injected ID No limitation to number of services descrambled per key Multi-BISS descrambling using up to 12 keys
Maximum TS bitrate:	200 Mb/s

IP Input/Output Module Option

General –	
Connector:	2x 10/100/1000 auto negotiate Base-T RJ-45 Ethernet Ports
Receive –	
Input Format:	UDP, RTP and RTP with extension headers Multicast and Unicast CBR, VBR, Null Stripped
Receiver Capability:	2 simultaneous MPEG over IP transport streams
FEC Receive:	Pro MPEG CoP3 SMPTE2022 Range: $L * D \leq 100$ $1 \leq L \leq 20$ $4 \leq D \leq 20$ Annex B
Multicast Filtering:	Filters based on IP address
Buffer size:	1 - 600 KB, or 1 – 4000ms user configurable
Bitrate Range:	.25 – 200 Mb/s
Packets/IP Frame:	1-7 MPEG Packets/IP Frame
IGMP Compatibility:	Version 2 and 3
Transmit –	
Output Format:	UDP and RTP
Bitrate Range:	.25 – 200 Mb/s
Packets/IP Frame:	1-7 MPEG Packets/IP Frame
Number of Outputs:	2 Mirrored TS – Unicast and/or Multicast
IP FEC Output (MRD44925) Adds –	
FEC:	Off, Columns, Columns/Rows
FEC Transmit:	Pro MPEG CoP3 SMPTE2022 Range: $L * D \leq 100$ $1 \leq L \leq 20$ $4 \leq D \leq 20$

DVB-S/S2/S2X Input Module Option

General –	
Frequency Range:	950 MHz – 2150 MHz
Number of inputs:	4 (A, B, C and D)
Connector:	F-81 Type, Female (4)
Impedance:	75 Ohms

Return Loss:	>9 dB
Separation:	>50 dB adjacent, >60 dB non-adjacent
RF frequency:	950 MHz to 2150 MHz in 100 kHz steps
Tuning:	Difference between Satellite frequency and LO frequency
Satellite frequency:	950 – 14500 MHz
LO frequency:	0 – 12000 MHz, with presets of 0, 5150, 9750, 10600, 10750 and 11250 MHz
Packet size:	188 bytes
Tuning Step Size:	125 kHz, maximum
Nyquist root filter roll-off factors:	.05, .10, .15, .20, .25, .35
RF Input Level:	-65 dBm to -25 dBm
Input RF Spectrum:	Normal/Inverted Auto Detect
PL Scrambling Codes supported:	0-262,141
Image Rejection:	>30dB
Noise Figure:	<15dB, maximum
Max TS Bitrate:	160 Mb/s
LNB Power and 22 kHz Tone –	
LNB Power	Off/13/14/18/19VDC @ >450mA
LNB voltage regulation:	± 4%
22 kHz Tone:	Off/On @ 650 mV (± 250 mV) peak-peak
DVB-S –	
Standard:	EN 300 421
FEC Code:	Conv. + Reed-Solomon
Modulation:	QPSK
Modulation/Coding supported:	CCM
Code rates:	1/2, 2/3, 3/4, 5/6, 7/8
QPSK Symbol rate:	0.5-60 MSym/s
DVB-S2 –	
Standard:	EN 302 307
Decoding type:	LDPC and BCH
Modulation:	QPSK, 8PSK
Modulation/Coding supported:	CCM
FEC Framing Type	Short frame size (16200), Normal frame size (64800)
Supported rates:	QPSK: 1/4, 1/3, 2/5, 1/2, 3/5, 2/3, 3/4, 4/5, 5/6, 8/9, 9/10 8PSK: 3/5, 2/3, 3/4, 5/6, 8/9, 9/10
Symbol rate:	0.5-60 MSym/s
Pilot:	On/Off Auto Detect
DVB-S2 Advanced (MRD 44916) Adds –	
Modulation:	16APSK, 32APSK
Modulation/Coding:	VCM
Supported Rates:	16APSK: 2/3, 3/4, 4/5, 5/6, 8/9, 9/10 32APSK: 3/4, 4/5, 5/6, 8/9, 9/10
Symbol Rate:	0.5-60 MSym/s
Multistream reception:	Single ISI (stream specified)
ISSY:	Supported

DVB-S/S2 Input Module Option

General –

 Frequency Range: 950 MHz – 2150 MHz

Number of inputs:	4 (A, B, C and D)
Connector:	F-81 Type, Female (4)
Impedance:	75 Ohms
Return Loss:	>9 dB
Separation:	>50 dB adjacent, >60 dB non-adjacent
RF frequency:	950 MHz to 2150 MHz in 100 kHz steps
Tuning:	Difference between Satellite frequency and LO frequency
Satellite frequency:	950 – 14500 MHz
LO frequency:	0 – 12000 MHz, with presets of 0, 5150, 9750, 10600, 10750 and 11250 MHz
Packet size:	188 bytes
Tuning Step Size:	125 kHz, maximum
Nyquist root filter roll-off factors:	.05, .10, .15, .20, .25, .35
RF Input Level	-65 dBm to -25 dBm
AFC Tuning Range:	± .5 MHz in Standard and Wide mode (with SR ≤ 2 MSps)
	± 1 MHz in Standard and Wide mode (with SR 2 ≤ 3 MSps)
	± 1.5 MHz in Standard and Wide mode (with SR 3 ≤ 4 MSps)
	± 2 MHz in Standard and Wide mode (with SR 4 ≤ 5 MSps)
	± 2.5 MHz in Standard and Wide mode (with SR 5 ≤ 6 MSps)
	± 3 MHz in Standard mode (with SR ≥ 6 MSps)
	± 4 MHz in Wide mode (with SR ≥ 6 MSps)
	± 5 MHz in Wide mode (with SR ≥ 6 MSps)
	Standard / Wide modes user selectable
Input RF Spectrum:	Normal/Inverted Auto Detect
PL Scrambling Codes supported:	0-262,141
Image Rejection:	>30dB
Noise Figure:	<15 dB Maximum
Max TS Bitrate:	160 Mb/s
LNB Power and 22 kHz Tone –	
LNB Power	Off/13/14/18/19VDC @ >450mA
LNB voltage regulation:	± 4%
22 kHz Tone:	Off/On @ 650 mV (± 250 mV) peak-peak
DVB-S –	
Standard:	EN 300 421
FEC Code:	Conv. + Reed-Solomon
Modulation:	QPSK
Modulation/Coding supported:	CCM
Code rates:	1/2, 2/3, 3/4, 5/6, 7/8
QPSK Symbol rate:	0.5-60 MSym/s
DVB-S2 –	
Standard:	EN 302 307
Decoding type:	LDPC and BCH
Modulation:	QPSK, 8PSK

Modulation/Coding supported:	CCM
FEC Framing Type	Short frame size (16200), Normal frame size (64800)
Supported rates:	QPSK: 1/4, 1/3, 2/5, 1/2, 3/5, 2/3, 3/4, 4/5, 5/6, 8/9, 9/10 8PSK: 3/5, 2/3, 3/4, 5/6, 8/9, 9/10
Symbol rate:	0.5-60 MSym/s
Pilot:	On/Off Auto Detect
DVB-S2 Advanced (MRD 44916) Adds –	
Modulation:	16APSK, 32APSK
Modulation/Coding:	VCM
Supported Rates:	16APSK: 2/3, 3/4, 4/5, 5/6, 8/9, 9/10 32APSK: 3/4, 4/5, 5/6, 8/9, 9/10
Symbol Rate:	0.5-60 MSym/s
Multistream reception:	Single ISI (stream specified)
ISSY	Supported

8VSB/QAM Input Module Option

General –

Frequency Range:	50 MHz – 1000 MHz VHF/UHF (Ch2 – Ch69) CATV (Ch2 – Ch158)
Channel Plans:	Off Air, FCC, IRC, HRC
Number of inputs:	1
Connector:	F-Type, Female
Impedance:	75 Ohms
Sensitivity:	-34dBmV to + 40dBmV (A74 Compliant)
Modulation:	8VSB, QAM-B
MER:	Range: 0dB to 40dB Accuracy: +/- 2dB Low Limit Flag: User Defined
RF Level:	Range: -34dBmV to +40dBmV Accuracy: +/- 5dBmV Low Limit Flag: User Defined

QAM –

Standard:	ITU Annex B/SCTE DVS-031
QAM Mode:	64 and 256
De-interleaver:	I=1-128, J=128/1
Nyquist Roll Off (Alpha):	12%, 18%

8VSB –

Standard:	ATSC A/53E
Decoding Levels:	8
Nyquist Roll Off (Alpha):	11.5%

DVB-T2/C2/ISDB-T Input Module Option

General –

Frequency Range:	42 MHz – 1002 MHz
Number of inputs:	1
Connector:	F-Type, Female
Impedance:	75 Ohms
Sensitivity:	-34dBmV to + 40dBmV (A74 Compliant)
Modulation:	QPSK, 16QAM, 32QAM, 64QAM, 128QAM, 256QAM, 1024QAM, 4096QAM

MER:	Range: 0dB to 40dB Accuracy: +/- 2dB Low Limit Flag: User Defined
RF Level:	Range: -34dBmV to +40dBmV Accuracy: +/- 5dBmV Low Limit Flag: User Defined

Appendix D – Pinouts for Analog Audio and Relay Connectors



(DB-15) ANALOG AUDIO 1-2

PIN	CHANNEL	FUNCTION
1	Channel 1	Left +
2	Channel 1	Right +
3	Channel 2	Left +
4	Channel 2	Right +
5	--	--
6	Channel 1	Left -
7	Channel 1	Right -
8	Channel 2	Left -
9	Channel 2	Right -
10	--	--
11	--	Ground
12	--	Ground
13	--	Ground
14	--	Ground
15	--	Ground

(DB-15) ANALOG AUDIO 3-4

PIN	CHANNEL	FUNCTION
1	Channel 3	Left +
2	Channel 3	Right +
3	Channel 4	Left +
4	Channel 4	Right +
5	--	--
6	Channel 3	Left -
7	Channel 3	Right -
8	Channel 4	Left -
9	Channel 4	Right -
10	--	--
11	--	Ground
12	--	Ground
13	--	Ground
14	--	Ground
15	--	Ground

(DB-9) RELAY PINOUT

PIN	RELAY	FUNCTION
1	Relay 1	Normally Open
2	Relay 1	Normally Closed
3	Relay 2	Common
4	Relay 3	Normally Open
5	Relay 3	Normally Closed
6	Relay 1	Common
7	Relay 2	Normally Open
8	Relay 2	Normally Closed
9	Relay 3	Common

**DB-9 Connector
(Female) Pin #'s**

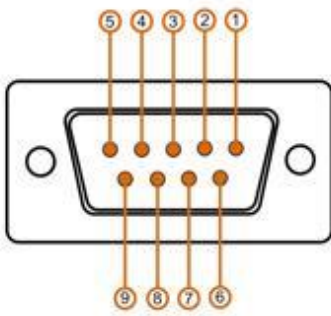

**DB-15 Connector
(Male) Pin #'s**

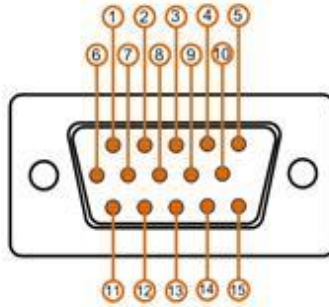

Note: Relay functions shown represent the MRD in a powered-on state with no active alarms.

Appendix E – MRD 4400 Audio Explanation

Audio Setup

There are two primary modes of audio down mix operation for the MRD 4400 receiver/decoders. These settings only affect the signal if the digital output is set to PCM. It will also affect those embedded audio channels that are set to a PCM down mix. There are no gain changes or decoding if the digital or embedded outputs are set to Pass-through. The preset modes are Monitor (the default setting) and Transmission.

The first preset, Transmission, allows no changes by the customer. Transmission is intended to provide a limited dynamic range signal to drive a set top box or a transmitter. The Transmission mode does respond to dialog normalization data. It provides a gain boost of 11 dB and has compression to prevent the signal from overdriving a modulator. The 11dB gain boost is applied to the analog outputs, AES digital outputs set to PCM, and any embedded outputs set to PCM. It will not affect the gain of digital outputs or embedded outputs set to Pass-Through. It is intended to provide a similar audio level as a broadcast TV station signal through an RF modulator. The down mix includes the center and surrounds channels if they are present, and is represented as Lt/Rt. (left total, right total)

The second preset is Monitor. It has moderate processing, no gain boost and its down mix involves left and right channels only (Lo/Ro). The mode setting is Line as the default, but may be changed to RF, Custom 0 or Custom 1. In Line mode, the Dolby Dialog Normalization data is followed along with moderate processing. The default down mix setting for Monitor is Lo/Ro. The down mix may be changed to Lt/Rt or Lt/Rt/auto. Lt/Rt auto follows the embedded data in the stream if the producer has a preferred down mix. It will switch automatically between Lo/Ro and Lt/Rt depending on the data in the stream. If no mode is specified, the down mix will be Lt/Rt. In addition, the Dual Mono modes of operation may be selected. They will only have an effect if the stream is encoded as Dual Mono. Dual Left or Dual Right applies that signal to both left and right channels of the digital service, left and right channels of the analog outputs, and left and right channels of any embedded stream set to PCM. Selecting RF as the compression setting will add 11 dB of gain and the same processing as the Transmission mode to the analog outputs, AES digital outputs set to PCM, and any embedded outputs set to PCM.

There is an additional selection at the bottom of the Dolby setup pull-down menu. This allows selection between Professional Mode and Consumer Mode. In Professional Mode the built-in latency value is 32 msec for all formats. In Consumer Mode, this latency varies depending on the format. If you wish to monitor using a consumer receiver, you should choose Consumer Mode. The output sampling rate will always be 48 kHz, even in consumer. The Consumer/Pro identification bit will be set to Consumer. Normal operation in the air chain will use the Professional setting. This setting affects both Dolby Digital (AC-3) and Dolby Digital Plus.

If you want to run with no processing, choose Custom 1, Lo/Ro, and Dynamic Range disabled. This will still allow gain changes called for in the Dolby metadata via Dial-Norm settings in the stream.

Audio Output Settings

The digital audio services may be set to PCM (AES) or Pass-through (AES data) as an output. This applies to all available sources. The PCM setting will decode and automatically down mix an AC-3 or Dolby Digital Plus stream to two channels of AES audio. Pass-through simply passes thru the Dolby AC-3 data in an AES stream to be decoded by an external decoder such as the Dolby 568. Be aware the Dolby DP-568 is a professional decoder and always has a decoding latency of 32 msec. The older Dolby DP-564 has both professional and consumer modes of operation. If it identifies the Pro/Consumer ID bit as Professional, the latency will always be 32 msec. If it identifies the Pro/Consumer bit as Consumer, the latency will vary according to the format. Check the DP-564 manual for the actual latency values for Consumer mode. The analog channels can be assigned to any of the digital sources. The analog gain may be adjusted for the desired level. The gain setting does not affect the level of either the embedded audio or the digital services. A setting of +4 dBu provides an output of +4 dBu for a digital signal level of -20 dBFS. To check the audio output level, place the audio setup in Custom1 mode, down mix set to Lo/Ro, and the Dynamic Range disabled. This will remove any signal processing in the down mix. Set the digital service output being measured to PCM. A test stream of -20dBFS will output from the digital services as -20dBFS. If the analog channels are set to a gain setting of +4 dBu, the output should be +4 dBu plus or minus 0.5 dBu. The analog output level can be set in increments of 0.5 dBu from -10 dBu to +4 dBu referenced to a -20 dBFS digital input level. When you are setting the output levels it is suggested that an AC-3 stereo tone (2.0) be used as the source. Do not use a Dolby AC-3 5.1 tone source as your test signal. The five channels will down mix to a different level structure than a stereo signal depending on the down mix setting.

Downmix Reference Table

The following table is applicable for MPEG Audio (Mono and Stereo), Dolby Digital (Mono, Stereo and 5.1), Dolby Digital Plus (Mono, Stereo and 5.1) and AAC (Mono, Stereo and 5.1).

Incoming audio PID -->	Downmix Option	--> Output effect
Stereo	Lo/Ro	OUT = IN
Stereo	Lt/Rt (DS)	OUT = IN
Stereo	Lt/Rt (Auto)	OUT = IN
Stereo	Dual mono	OUT = IN
Stereo	Dual left	OUT L = OUT R = IN L
Stereo	Dual right	OUT L = OUT R = IN R
Mono	Lo/Ro	OUT L = OUT R = IN
Mono	Lt/Rt (DS)	OUT L = OUT R = IN

Mono	Lt/Rt (Auto)	OUT L = OUT R = IN
Mono	Dual mono	OUT L = OUT R = IN
Mono	Dual left	OUT L = OUT R = IN
Mono	Dual right	OUT L = OUT R = IN
5.1	Lo/Ro	OUT L = L + C + Ls OUT R = R + C + Rs (per ATSC A52)
5.1	Lt/Rt (DS)	OUT L = L + C - Ls - Rs OUT R = R + C + Ls + Rs (per ATSC A52)
5.1	Lt/Rt (Auto)	Lo/Ro or Lt/Rt depending on dolby metadata
5.1	Dual mono	OUT L = front left OUT R = front right
5.1	Dual left	OUT L = OUT R = IN Lo
5.1	Dual right	OUT L = OUT R = IN Ro

Appendix F – MRD 4400 Discrete Audio Configuration

Audio Setup

Selecting the discrete option differs from downmix in that it simply decodes the selected audio channels rather than downmixing multiple channels into 2 channels. The service selection mode from 4.2.8 must be set to PID lock in order to output 3 pairs of audio (and completely decode a full 5.1 input). Assign the audio pid containing the 5.1 audio service to 3 separate audio components. The example below illustrates this with PID 558.

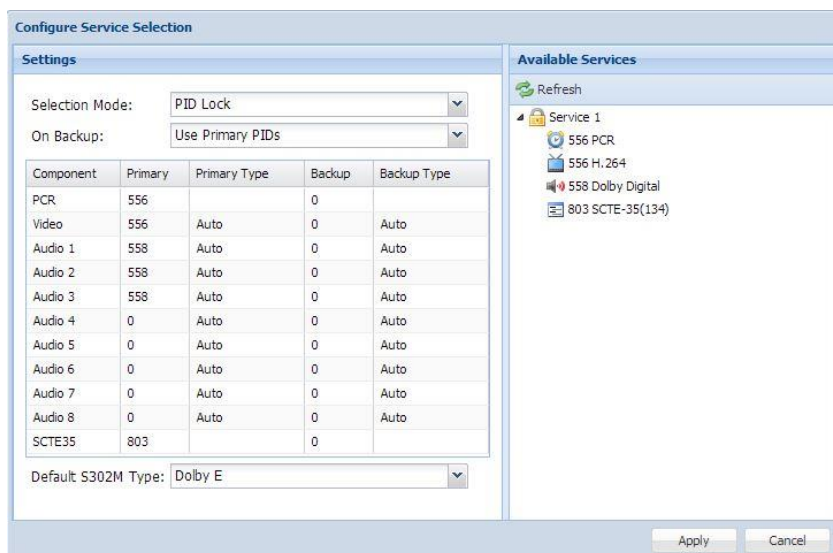

Desired discrete channels can then be selected for the assigned audio as illustrated below.

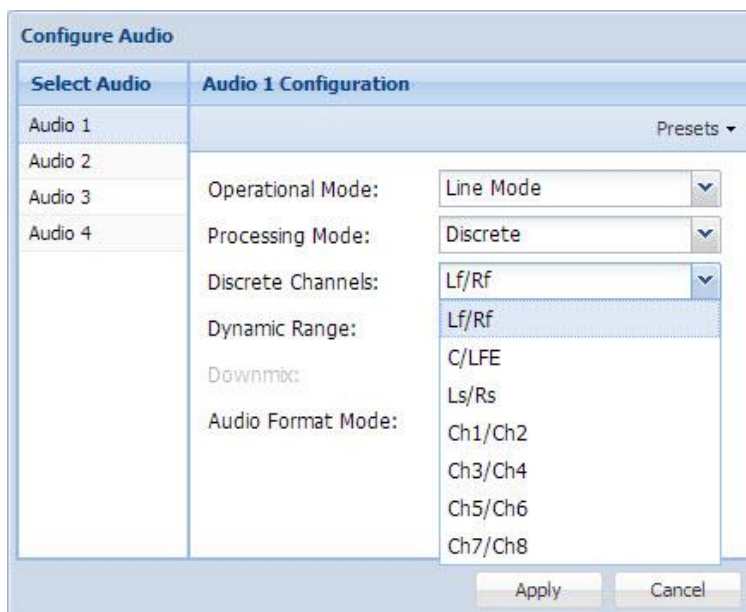

For audio services that indicate the specific channels (Lf, Rf, C, Ls, Rs, LFE) the user can select the audio channels to assign to a output using the named discrete options. If the specific channels are not identified (LPCM Audio for example) than the user can use the multi-channel audio service to select the channel pair of the audio service to output. When the user has selected a named discrete option but the audio channels are not identified in the service the unit will output Ch1/Ch2 (if present) if Lf/Rf is chosen, Ch3/Ch4 (if present) if C/LFE is chosen and Ch5/Ch6 (if present) if Ls/Rs is chosen.

The following audio formats identify specific channels.

Dolby Digital

Dolby Digital Plus

AAC-LC

HE-AAC version 1

Appendix G – Open Source Software

The MRD 4400 includes:

Package	Version	License	Copyright
AT32 UC3B Software Framework	1.7.0	BSD	2009, Atmel Corporation
BaseX4JIT	4.0	GPL Version 3, 29 June 2007	2007-2009, Active Group, Inc
BusyBox	1.20.1	GPL Version 2, June 1991	Erik Anderson, et. al.
Cgicc	3.2.9	LGPL Version 29, June 2007	Stephen F. Booth
dfu-programmer	0.5.2	GPL Version 2, June 1991	Weston Schmidt
Dropbear	2012.55	MIT-like	2002-2008 Matt Johnston, et. al (see license)
E2fsprogs	1.41.9	GPL Version 2, June 1991	Theodore Ts'o
ethtool	2.6.34	GPL Version 2, June 1991	David Miller, et. al.
FamFamFam Silk Icons	013	Creative Commons Attribution 2.5	Mark James
FastDB	3.71	MIT-like	Konstantin Knizhnik
FCGI	2.4.6	FastCGI	Open Market, Inc
Iproute2	3.4.0	GPL Version 2, June 1991	Stephen Hemminger, Alexey Kuznetsov
Libusb	0.1.12	GPL Version 2.1, Feb 1999	Johannes Erdfelt, Thomas Sailer, Brad Hards
Lighttpd	1.4.23	BSD	2004, Jan Kneschke
Linux	2.6.30	GPL Version 2, June 1991	Linus Torvalds, et. Al.

Log4cpp	1.0	GPL Version 2.1 Feb 1999	Bastiann Bakker
Monit	5.1.1	GPL Version 3, 29 June 07	2010 Tildeslash Ltd.
Net-SNMP	5.7.1	BSD	1989, 1991, 1992 by Carnegie Mellon Univsty.
NTP	4.2.4p7	NTP License	1992-2009 David L. Mills
OpenSSL	1.0.1c	BSD-Like	1998-2008 The OpenSSL Project, 1995-1998
OProfile	0.9.7	GPL Version 2, June 1991	John Levon, Philippe Elie, et. al
PCRE	8.00	BSD	1997-2009 University of Cambridge, 2007-2008
POPT	1.14	MIT	1998 Red Hat Software
qDecoder	12.0.2	BSD	200-2012 Seungyoung Kim
Socket-CAN	1171	BSD-like, GPL Version 2, June 1991	2002-2007 Volkswagen Group Electronic Research
Spawn-FCGI	1.6.3	BSD	Jan Kneschke, Stefan Bahler
TCLAP	1.2.0	MIT	2003 Michael E Smoot
U-Boot	2009.11.1	GPL Version 2, June 1991	Wolfgane Denk, et. al.
USB-Utills	0.86	GPL Version 2, June 1991	Thomas Sailer, Johannes Erdfelt, David Brownell,
Zlib	1.2.3	Zlib/libpng License	1995-2005 Jean-loup Gailly and Mark Adler

Appendix H – Warranty

Sencore One-Year Warranty

Sencore warrants this instrument against defects from any cause, except acts of God and abusive use, for a period of 1 (one) year from date of purchase. During this warranty period, Sencore will correct any covered defects without charge for parts, labor, or recalibration.

Appendix I – Support and Contact Information

Returning Products for Service or Calibration

The MRD 4400 is a delicate piece of equipment and needs to be serviced and repaired by Sencore. Periodically it is necessary to return a product for repair or calibration. In order to expedite this process please carefully read the instructions below.

RMA Number

Before any product can be returned for service or calibration, an RMA number must be obtained. In order to obtain a RMA number, use the following steps:

1. Contact the Sencore service department by going online to www.sencore.com and select Support.
2. Select Service and Repair from the options given.
3. Fill in the following required information:
 - a. First & Last Name
 - b. Company
 - c. Email
 - d. Phone Number
 - e. Ship and Bill to Address
 - f. Unit Model and Serial Numbers
4. A RMA number will be emailed you shortly after completing the form with return instructions.

Shipping the Product

Once an RMA number has been issued, the unit needs to be packaged and shipped back to Sencore. It's best to use the original box and packaging for the product but if this not available, check with the customer service representative for the proper packaging instructions.

Note: DO NOT return any power cables or accessories unless instructed to do so by the customer service representative

